

Ultra SPADstick



Wingspan: 81 inches

Length: 61" (firewall to aft edge of rudder)

Weight: Approx 13 1/2 pounds

Recommended Engine: 31cc to 45cc

Channels: 5 - Ailerons, Elevator, Rudder, Throttle & Flaps

Servos required: 8 - standard servos

I made the Ultra SPADstick because I wanted a plane with a "gasser" engine on it - and - I wanted to make a really big SPAD!!!! I decided that I wanted to build another "stick" type plane because I really like the way they look - and I thought it would be a great platform for my newly converted Ryobi 31cc engine! The plans are presented in a way that "assumes" that you already have an "average" amount of SPAD building experience - because I don't discuss how to glue, or how to attach your engine, or how to stuff your radio gear in detail. The plans are also presented "as is" - meaning - the following plans show exactly how I built mine - and any changes or substitutions you make, could affect the strength or flying qualities of this plane - so, with that said - the builder and/or pilot of any SPAD assumes all risks. This is not a beginners plane - although it could be used to teach someone how to fly - the building process is quite in depth for a SPAD.

BTW - You'll notice in some of the pictures that the tail has an airfoil shape to it - and the plans show a doubled over flat tail - just ignore that airfoil tail - I changed the design on the second prototype, and I didn't have any current photos available with the newer tail design!!! Overall the plane flies very smooth and nice - and the sound of the "gasser" on the front is really cool! Now let's get to building!

Collin "Kraut" McGinnis

Things needed to build an Ultra SPADStick

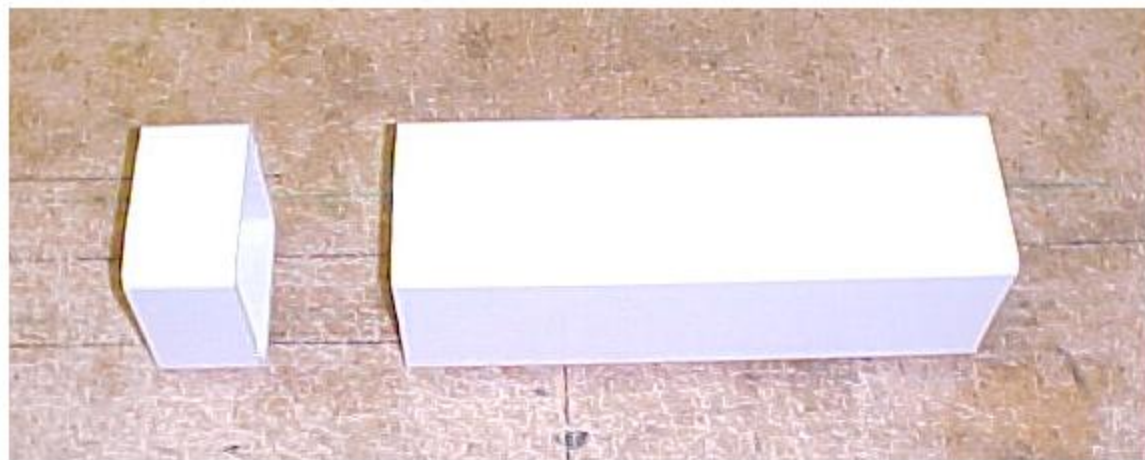

You will need two pieces of 3 1/2 inch square vinyl fence post - one measuring 2 inches long, and the other measuring 11 inches long. The long piece will be used on the front to mount the firewall to, and as the landing gear doubler. The short piece will be used as a former in the fuselage to help hold the fuselage square. Make sure that at least one edge of the forward former (big one) is square.

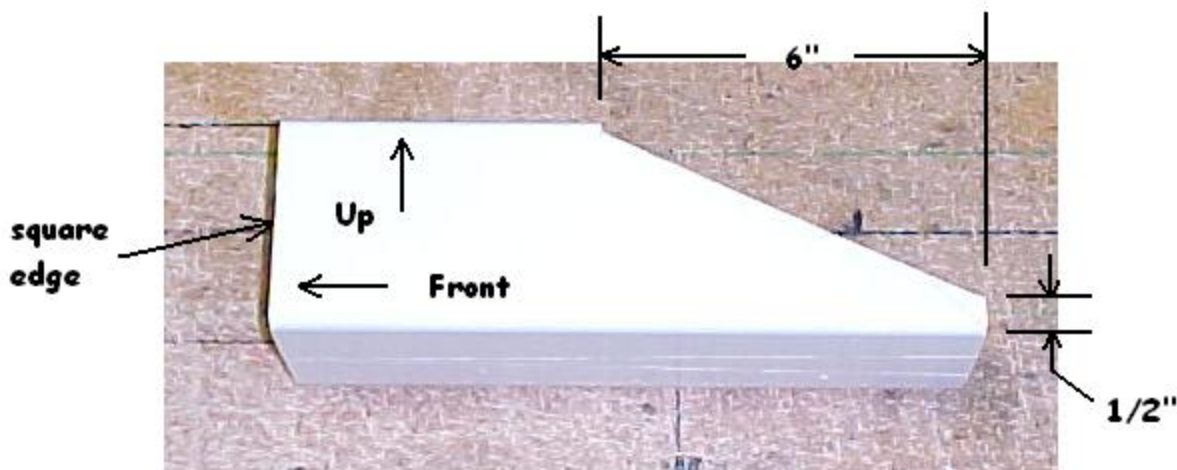

Cut out the aft part of the front fuselage former using the above measurements as a guide. The reason I cut the chunk off of the back is to reduce the weight a bit - I don't think the entire former is necessary.

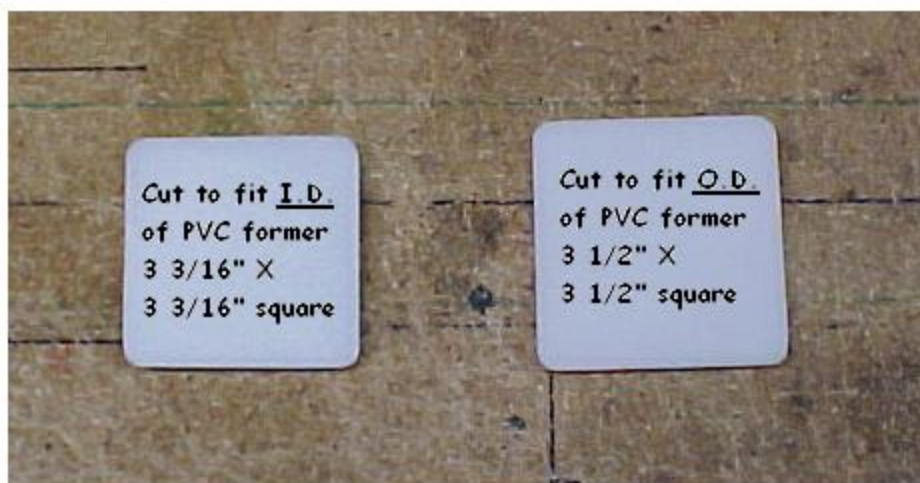

Cut out two pieces of 1/2" Poly for the firewall (I got mine at Lowes). One piece is cut to the I.D. of the PVC former, and the other is cut to the O.D. of the PVC former. They will be screwed together to make a one piece firewall. By making the firewall in this manner - I was able to get a fairly thick firewall (1" total thickness) without having to buy thick poly (which could be hard to find!)

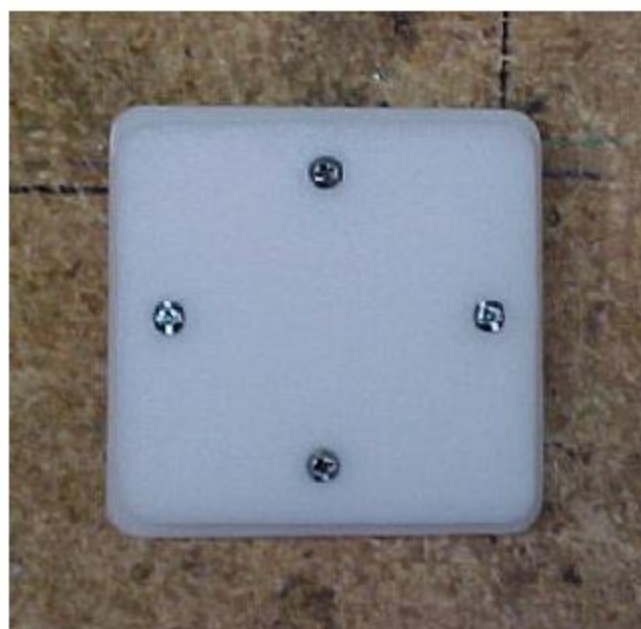

Round the corners off and then lay the smaller firewall on top of the bigger firewall (centered) - then fasten the two firewalls together by using four #6 X 3/4" sheetmetal screws - don't worry about the strength of the four screws, they are only there to help hold things together until the engine is mounted. The main structural integrity will be finalized by the engine mount bolts and blind nuts. The placement of the 4 screws isn't critical - just make sure they won't interfere with the engine mount bolts and the fuel lines.

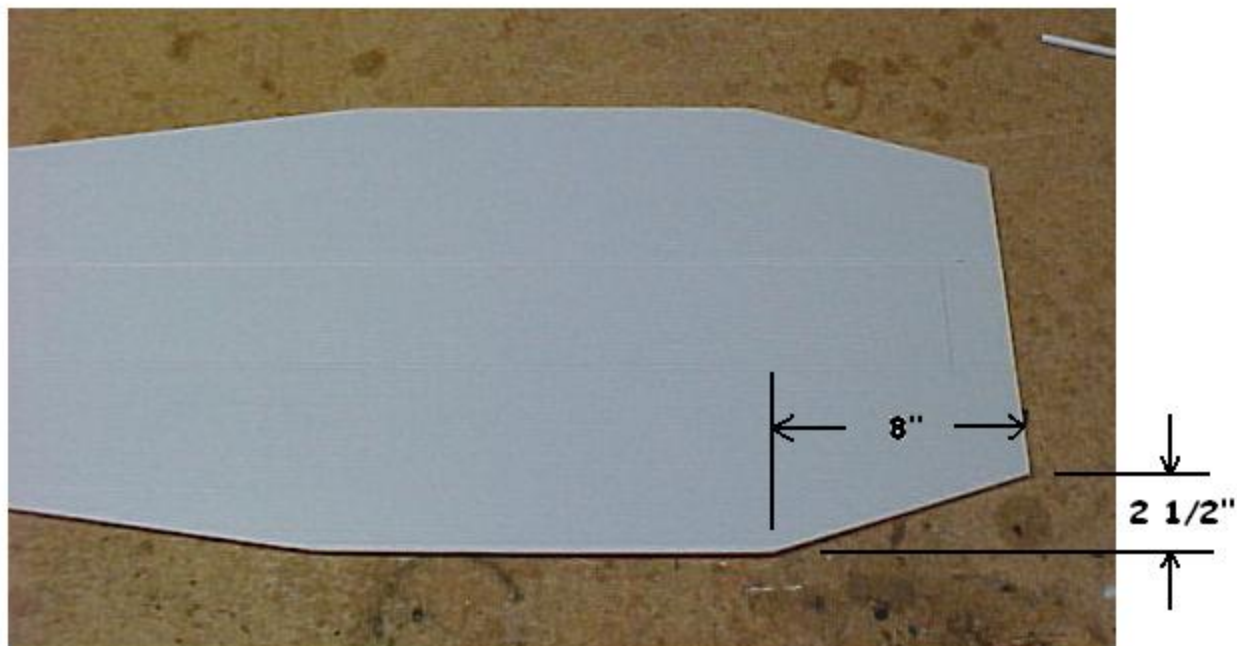

Cut a piece of 4 mil Coroplast to 56" X 16 1/4" - with the flutes running in the 56" direction. Cut out the front angle following the above dimensions.

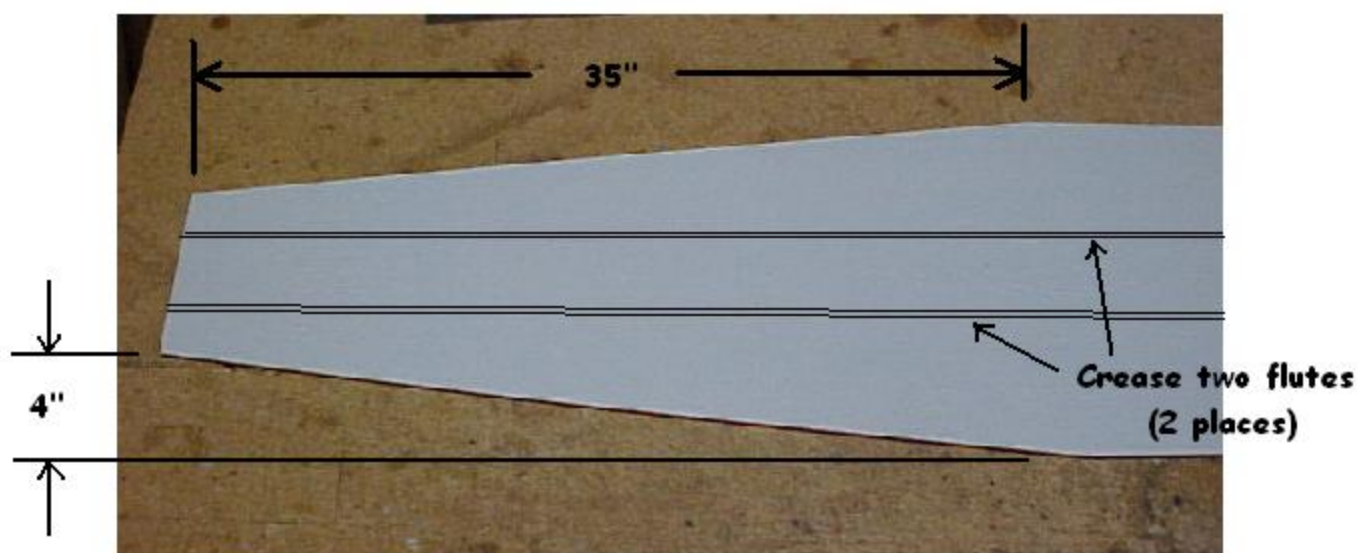

Cut the aft angle using the above dimensions as a guideline. Once you have the angles cut - measure in from one edge (where the side is still straight) approximately 6 inches - and score that flute - and the one right next to it - the entire length of the fuselage. This will be where the fuselage side will fold up. Lay one of the PVC formers on the fuselage piece (approximately where it will be located - see next page for reference), then fold up the fuselage side so you can mark where the edge is to determine where to crease the next two flutes for the other fuselage side. Once you have creased the flutes - fold up the other fuselage side and ensure that both sides are exactly the same height. If one side is taller - simply cut it off so that both sides are then the same.

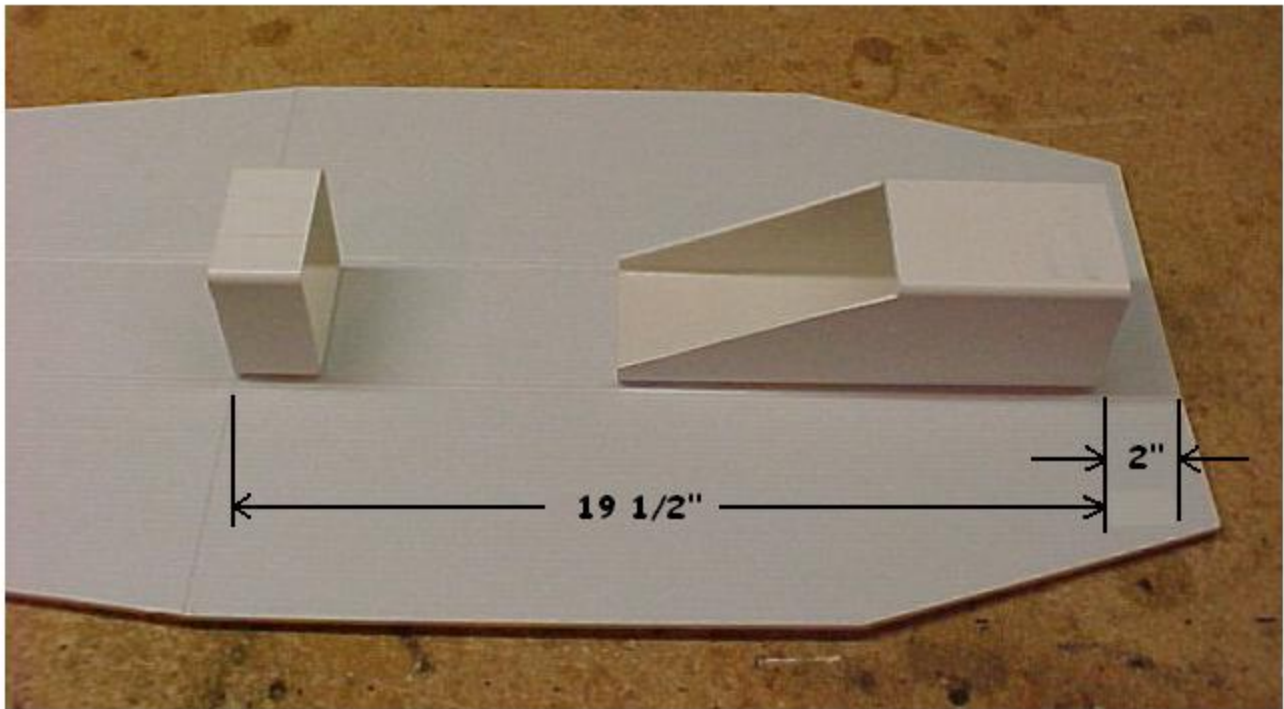

Once you have creased the flutes for the sides - position the two PVC formers so that they are centered and square between the creased flutes, at the locations shown above. Once you are happy with the fit - glue them down with CA to the fuselage bottom piece (like shown above)



After the glue has dried - fold up the sides and glue them to the sides of the PVC formers. Make sure that the fuselage stays square and true. I used a 20 pound chunk of metal to help clamp the sides until the glue dried.

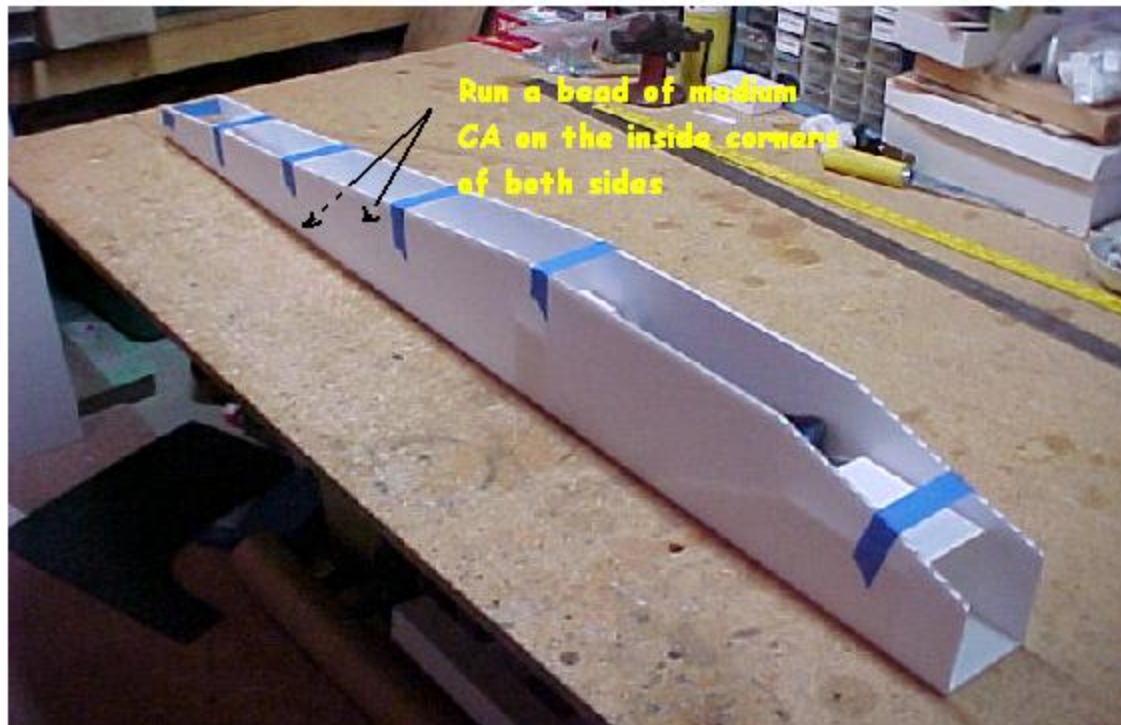

Once the glue on the sides has dried - turn the fuselage upright and run a bead of medium CA glue down the aft inside corners (both sides) of the fuselage (from the aft PVC former to the aft edge of the fuselage) - this will ensure that the sides stay angled close to 90 degrees by themselves. Once you have run the bead of glue - tape the fuselage (as shown above) until the glue dries - this will help hold the sides nice and square. I used some weights placed inside the fuselage to help hold the fuselage down on the table to ensure that the entire assembly stays square and true.

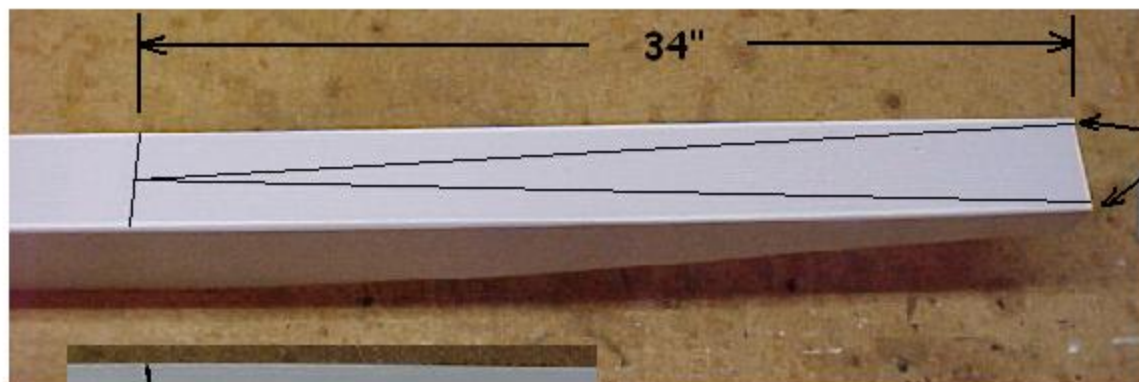

4 mil gap
on each side
(for vert stab
clearance)



Close up of forward lines

Mark and cut out the rear fuselage taper as shown in these two pictures. Make sure that you leave a 4 mil gap on each side (on the aft end) to allow enough room for the vertical stab to fit. The vertical stab is made from two layers of 4 mil sandwiched together (vertical stab will be built next)

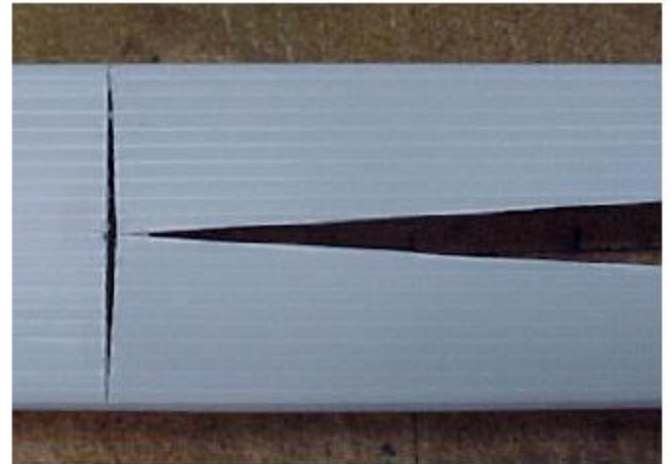

Cut out the aft taper as shown above. The sides should pull in nicely after making the cuts. Notice how the forward part of the taper should look when it's complete. Once you get the taper cutout done flip the fuselage over so you can glue a yardstick doubler in to help hold the tapered part of the fuselage together.

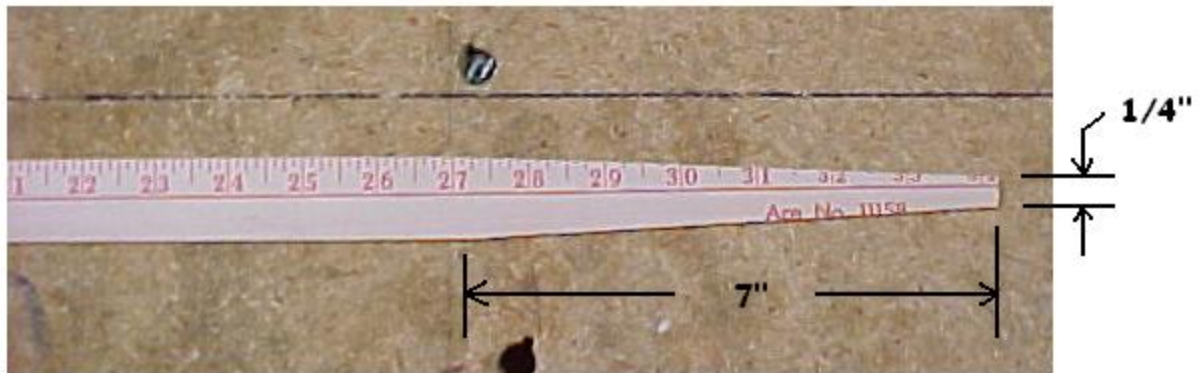

Cut a yardstick down to 34 inches, and taper the aft part as shown above. This piece will be used as a doubler to help hold/reinforce the fuselage where the taper is cut out. The doubler installs in the inside part of the fuselage.

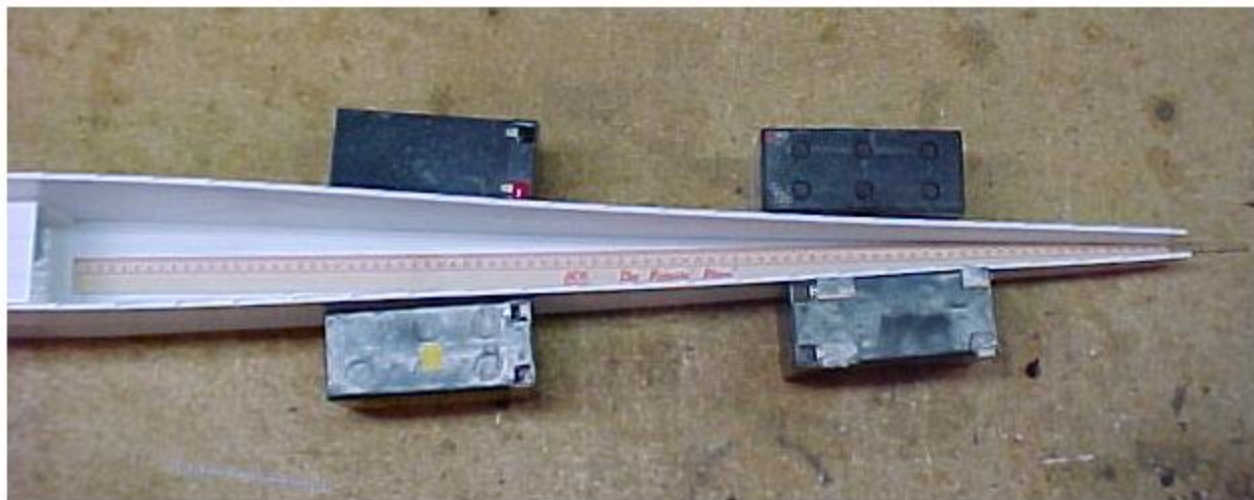

Pull the sides of the fuselage together - ensuring that the sides stay square, and that they stay straight. Test fit the yardstick doubler, and, once you are satisfied with its fit - glue it on place with CA. I used four small batteries to help hold the sides in until the yardstick doubler was glued in place, and the glue was fully cured. Notice the gap at the aft end of the fuselage sides - it should measure eight (8) mil wide at this point - to allow room for the vertical stab/rudder assembly to fit nice and snug. Make sure that the doubler covers the entire length of the fuselage where you made all the cuts. If you look closely - you can see that the doubler goes all the way from the PVC fuselage former, to the very aft edge of the fuselage.

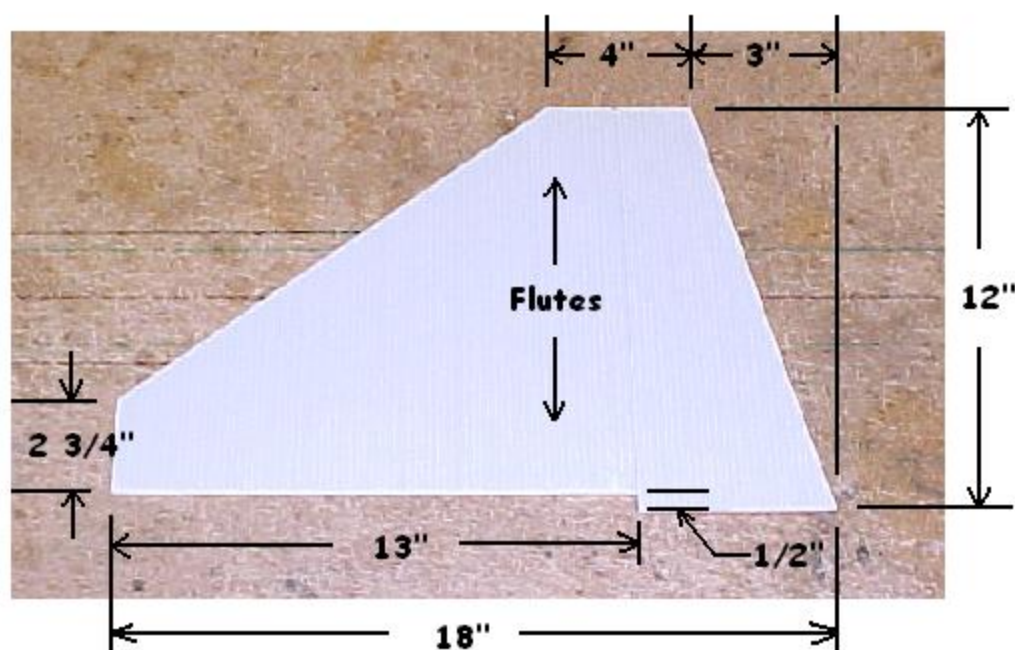

Cut out 2 each vertical stab/rudder assemblies as shown above. Make sure that you cut out two identical pieces - because they will be glued together in the next step to form an eight (8) mil thick vertical stab/rudder assembly. Sandwiching the two parts is necessary to ensure that the structure is strong enough to prevent failure, and/or flutter.

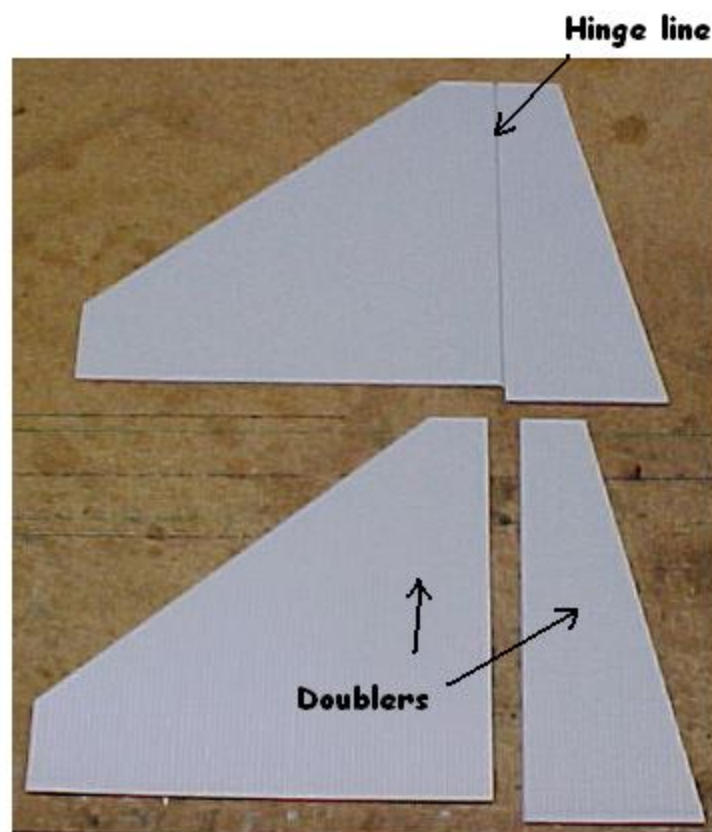

After you have both vertical stab/rudder pieces cut out, you will need to hinge the rudder on one of the vert stab/rudder pieces, and you will need to cut the rudder completely off of the other side (I'll call it the doubler) - as shown to the left. Next, check the fit of the two doubler parts by laying the separated pieces on top of the assembly. Once the fit is good, glue the pieces together with CA. Make sure that the hinge line gap is big enough (where you are gluing the doublers on) to prevent the rudder from binding. Make sure that the hinge is in the "middle" of the two pieces (as shown in the drawing below) to maximize rudder travel.

The cut-away drawing to the right shows the two vert stab/rudder pieces glued together - one half being the assembly, and the other half the doublers - and how the hinge line should look.

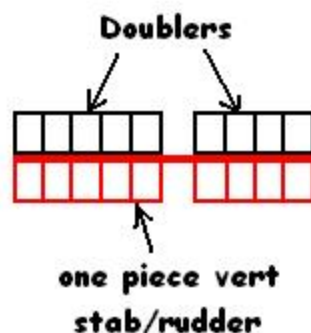

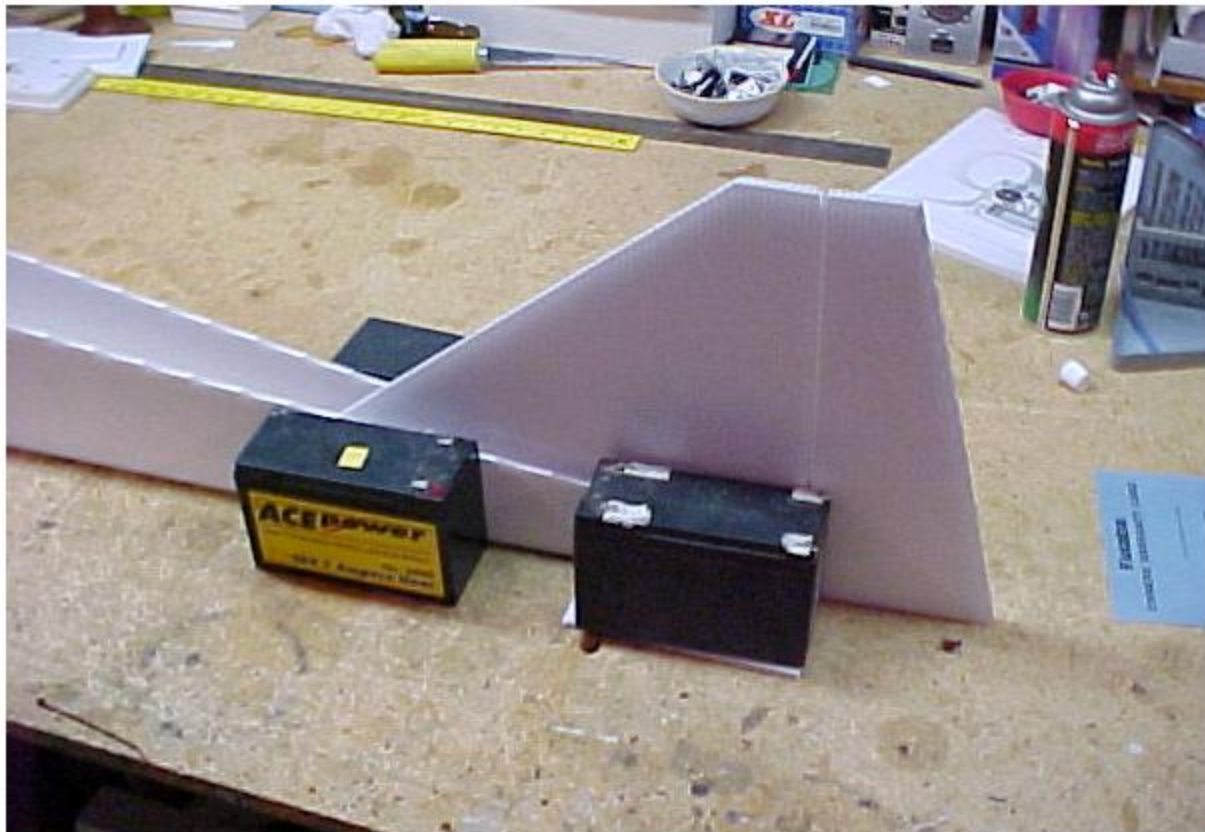

Once you get the vertical stab/rudder assembly completely built, it is time to glue it in place. I used Goop to glue the vertical stab/rudder assembly to the fuselage. Check the fit of the vertical stab/rudder, then apply a liberal bead of Goop to all the area that will make contact between the fuselage and the vertical stab assembly. Make sure that the rudder hinge line is just aft of the back edge of the fuselage (to prevent binding), and that the vertical stab portion is exactly straight within the fuselage. Be sure and wipe off any excess Goop that ends up where it's not supposed to be. I used some old batteries to help hold the assembly straight and true. Be sure to double check the vertical stab/rudder assembly (and fuselage) with a square to ensure that they are perpendicular to the table surface. Let this assembly dry over night. Next we'll make the horizontal stab/elevator assembly.

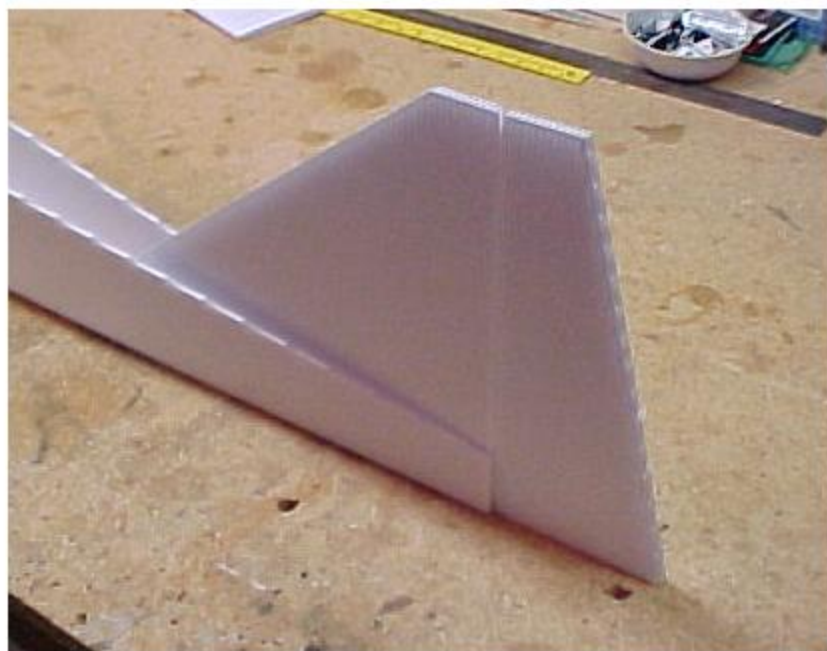

This is what the vertical stab/rudder assembly should look like once it is finished, and the glue is dry.

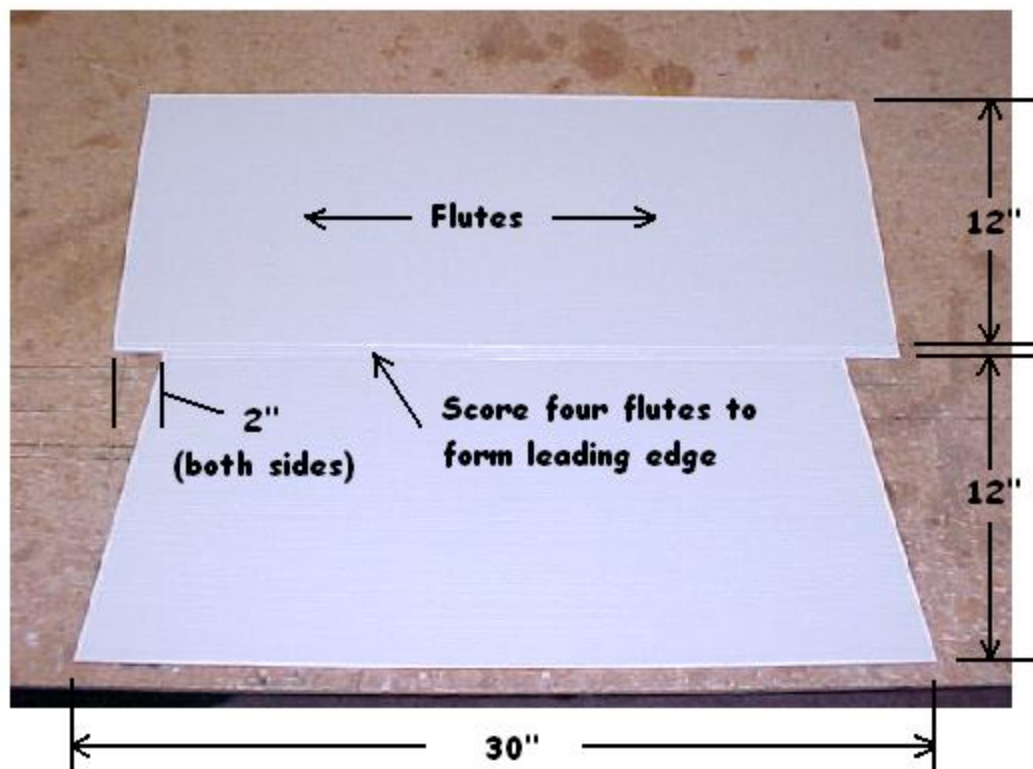

Cut out a piece of Coroplast measuring approximately 30" X 24" - with the flutes running in the 30" direction. Measure in from one long edge 12", and score that flute - and the next three (for a total of four), to form the leading edge of the wing. Measure in 2" from each side (at the middle of the four flutes). Now cut the Coroplast up to the middle of the four flutes to the mark you made 2" in from the side. This is to give the horizontal stab sides some taper. Next we will cut out the elevator, and we will cut out the hinge.

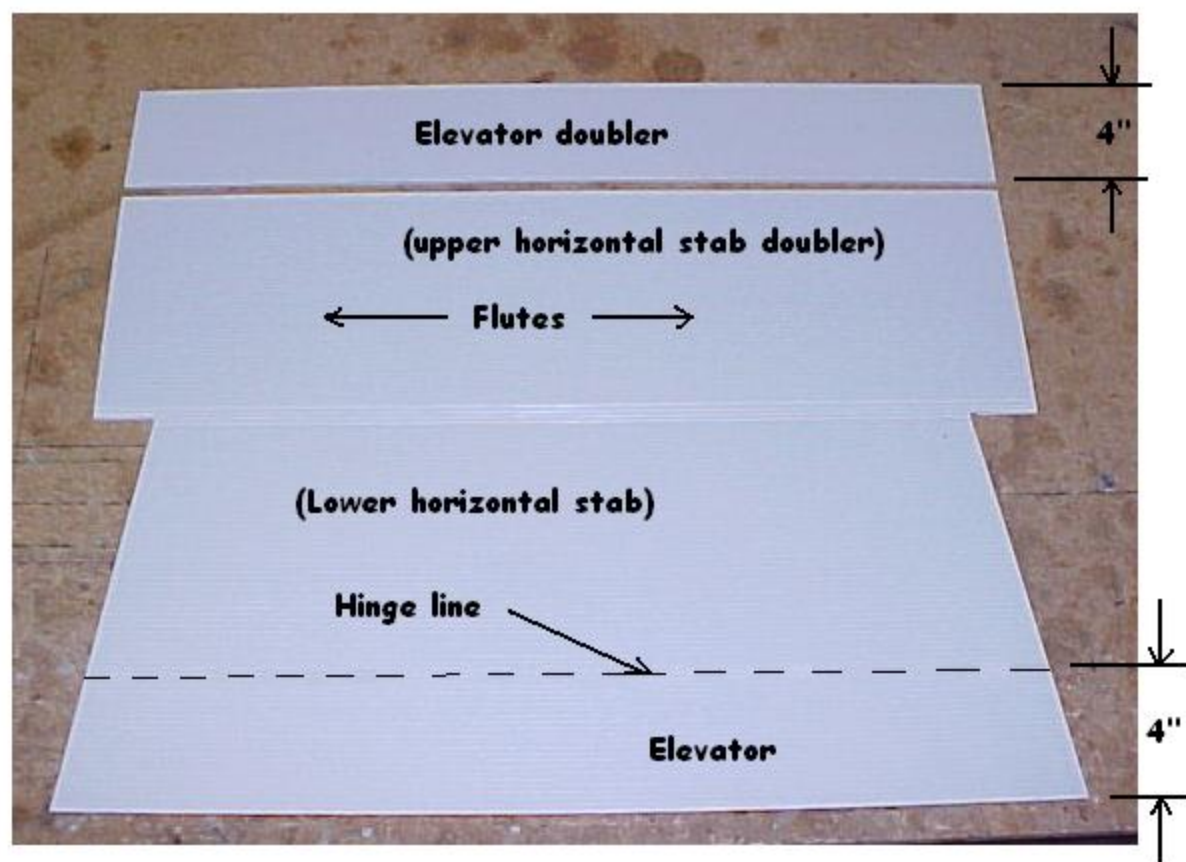

Measure in 4" from the bottom of the horizontal stab/elevator assembly, mark it, then cut out the bottom flute to make the hinge. Fold the top of the horizontal stab over the bottom piece, and mark where the hinge lines up with the flute on the top piece. Now cut off the 4" piece from the top to make the elevator doubler. Once you get the elevator cut off, and you have checked the alignment of the folded over pieces, glue the top horizontal stab and elevator to the bottom piece forming an 8 mil thick horizontal stab/elevator assembly.

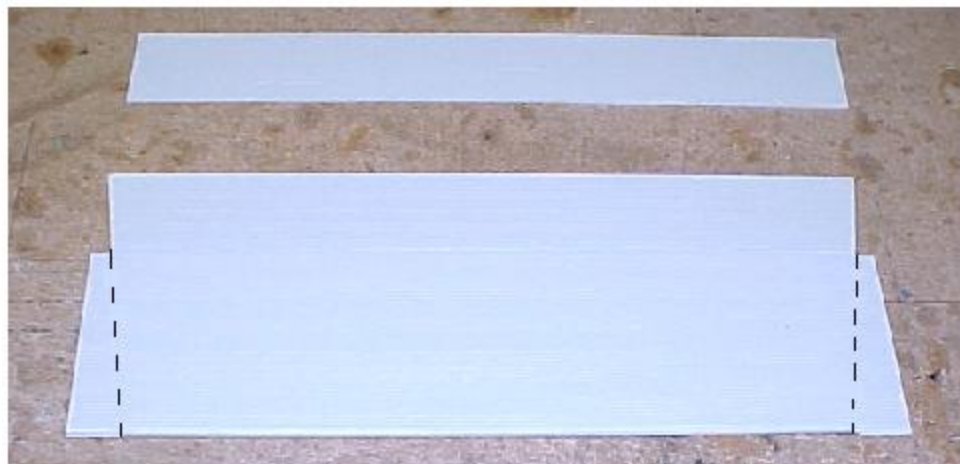

Once the glue has dried, cut off the edges of the upper piece to match the bottom piece. This picture shows the elevator doubler NOT glued in place - but once it is glued in place - trim the edges to match the bottom elevator angle.

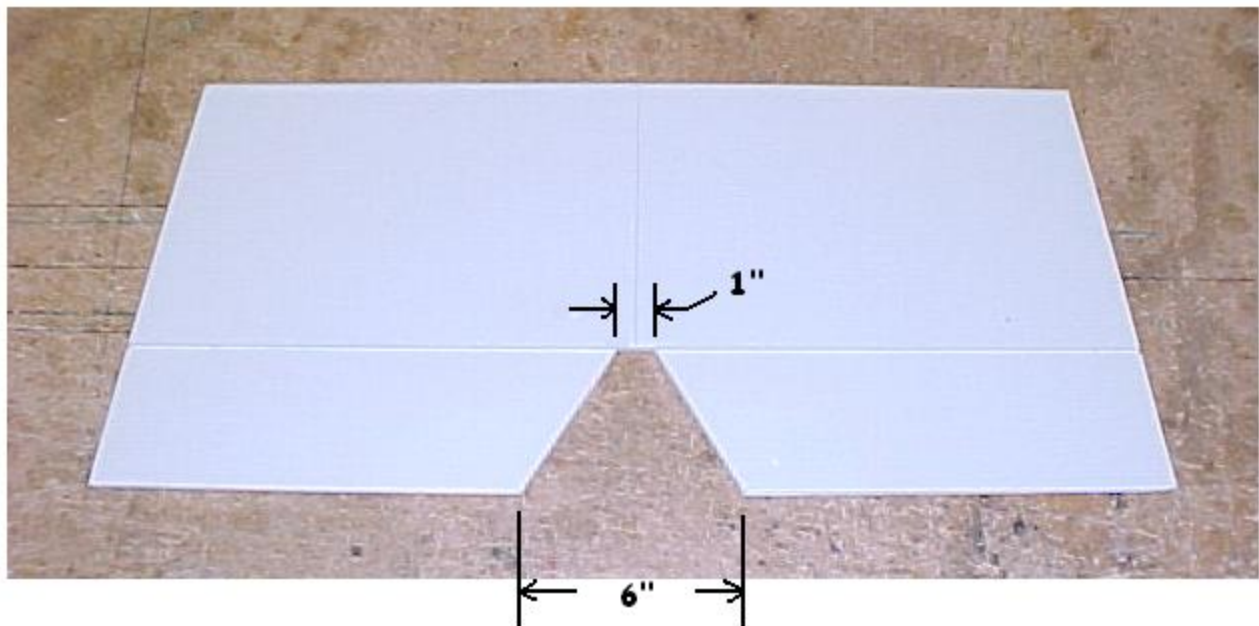

After you glue the elevator doubler in place, and the glue has cured, and, you trimmed off the edges of the overhang, cut out the center section of the elevator to allow for rudder clearance using the above dimensions as a guideline. Next we'll glue the horizontal stab/elevator assembly to the fuselage.

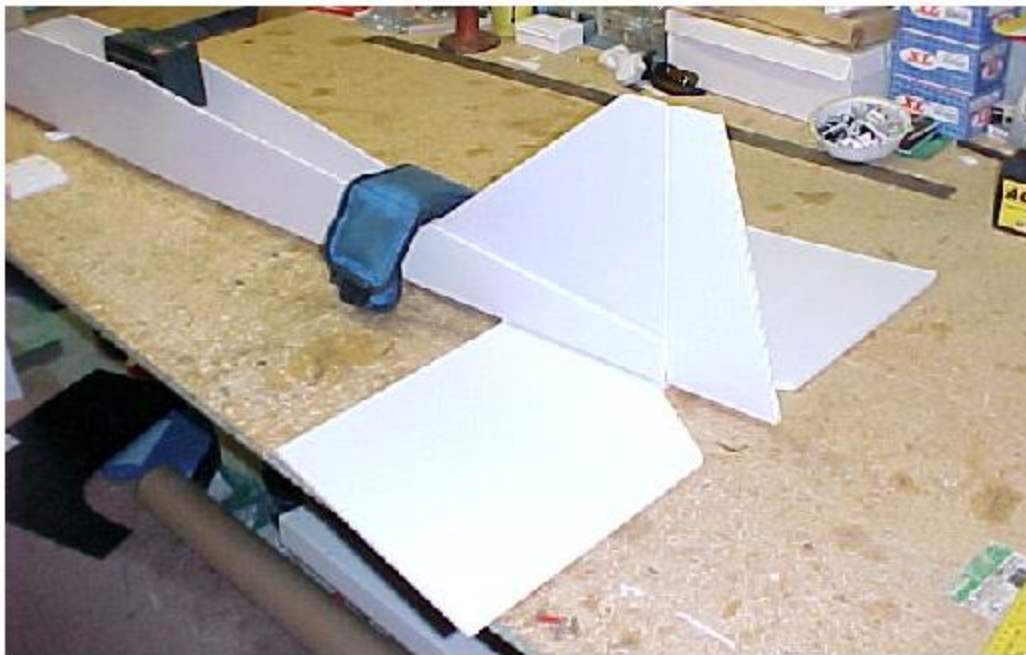

Place the hor. stab/elevator assembly under the aft part of the fuselage - with the elevator center cutout even with the bottom edge of the fuselage. Place the small scrap you cut out from the center of the elevator under the front of the fuselage (to keep the fuselage level). Make sure the hor. stab/elevator assembly is square and centered - then glue it in place with a liberal amount of Goop. Let dry overnight. Hold down with weights.

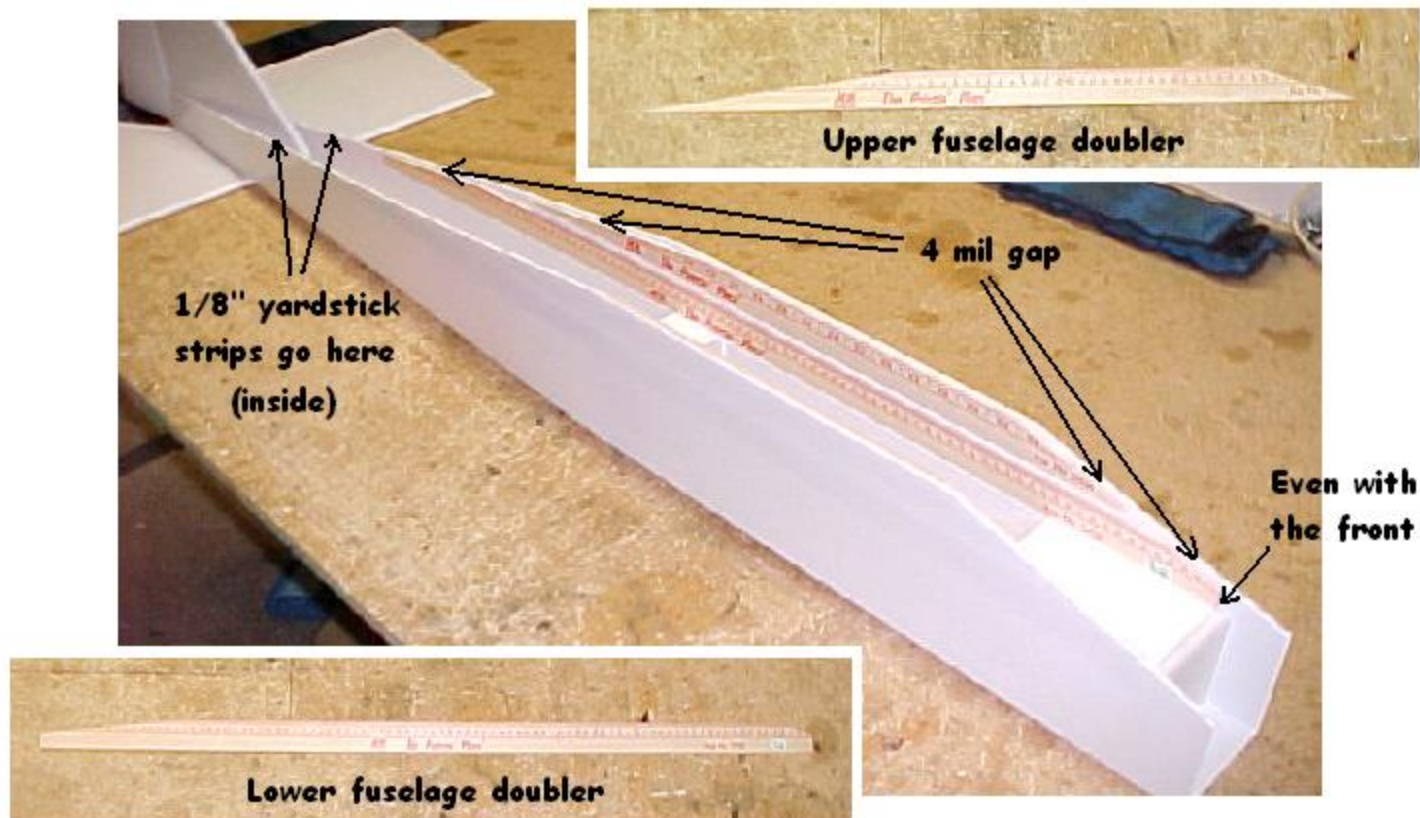

Now you need to make four fuselage doublers from four yardsticks (two for each side). For the lower fuselage doubler - take a full 36" yardstick and lay it on top of both of the PVC fencepost formers glued in the fuselage. Mark the angle of the forward and aft angles on the yardstick by drawing a line on the yardstick that matches the angle of the forward and aft angles. Now take the yardstick and measure in 4 mm down from the line you just drew to compensate for the width of the 4 mil Coroplast forward and aft covers that will be installed later. Make one for each side, check the fit, and glue in place with CA. Next - take another yardstick and hold it to the fuselage side just above the doubler you just installed. The upper doubler will be positioned even with the top of the fuselage (where the wings sits). Make sure that both sides of the fuselage wing saddle are level (so your wing can't sit on the saddle crooked). Mark the yardstick doubler like you did before - making sure you compensate for the 4 mil space needed for the forward and aft covers. Check the fit of the upper doubler and glue in place with CA. FYI - the gap between the lower doubler and the upper doubler on my plane is 3/8", but that is only for a reference - yours could be slightly more or less than 3/8". The picture above doesn't show it - but you need to glue in a strip of 1/8" x 1/8" yardstick just behind the doublers in the aft portion of the fuselage to finish the ledge for the aft upper cover that was started by the doublers. Make sure and put them on both sides. The 1/8" square strips go from the aft edge of the lower doubler to as far back as you can fit them between the vertical stab and the sides of the fuselage. Next we'll make and install the aft formers.

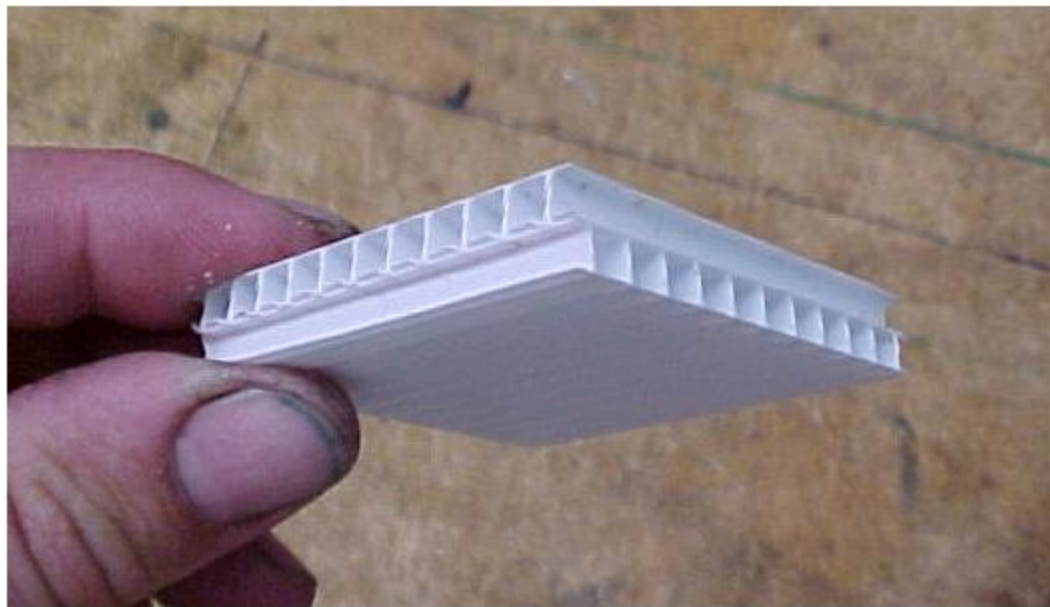

Make two bulkhead formers to help stiffen up the aft part of the fuselage. I used two pieces of 4 mil Coroplast cut into squares and then I glued them together with one turned 90 degrees from the other (like shown above). I used CA to glue them together. I cut one pair of formers 1 3/4" square, and the other measures 2 1/2" square. Place them in the fuselage where they just start fitting snug - mark their location - and then glue them in place with Goop making sure the formers are touching the bottom. Look at the picture below for a reference to the location where I placed mine. The exact location is not critical - just make sure that the formers fit snug to help hold the fuselage sides to minimize twisting. There will be a gap above the formers when they are installed - and that's OK - the gap allows room for the elevator and rudder servo wires to pass forward.

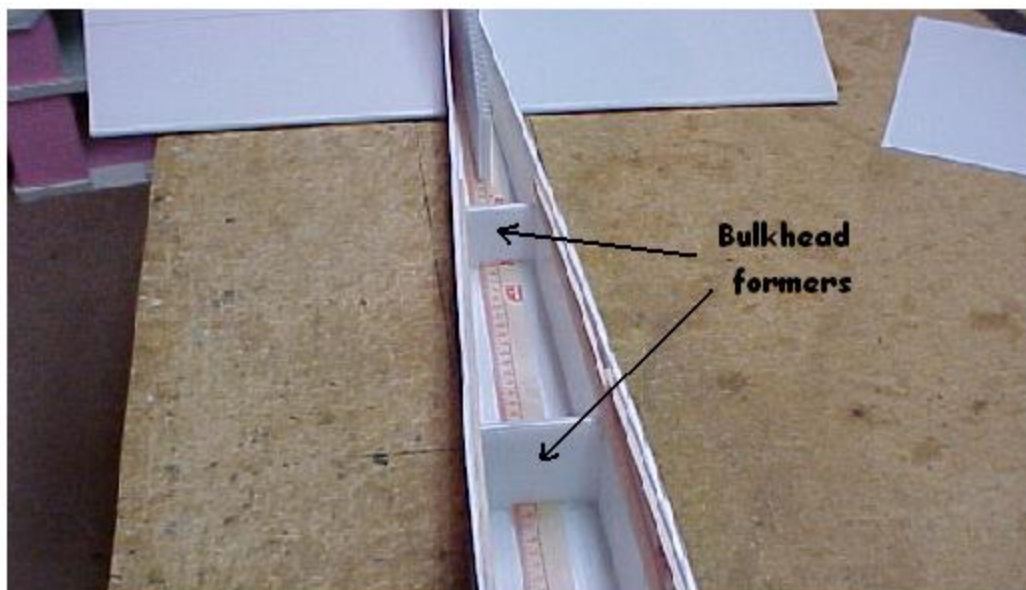

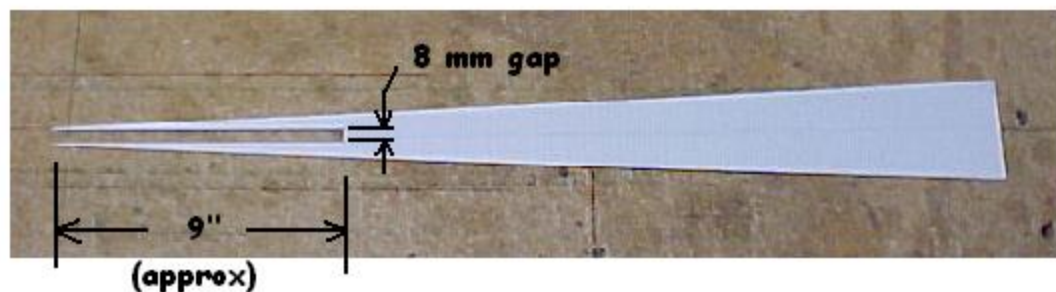
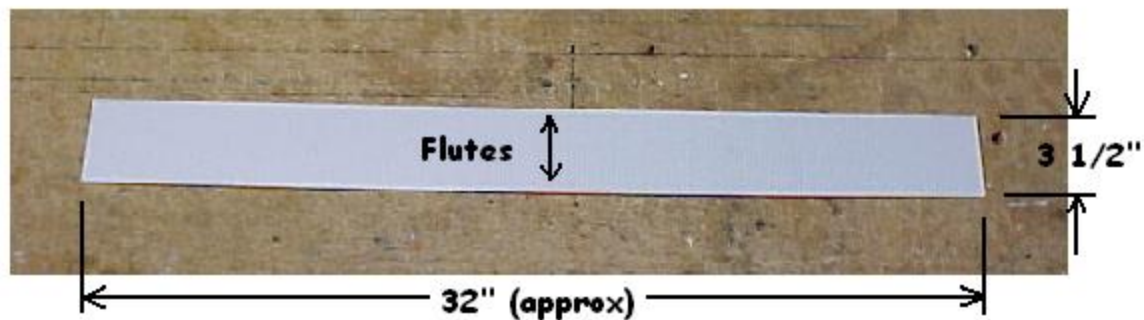

Cut out a piece of 4 mil Coroplast measuring 3 1/2" x 32" - with the flutes running in the 3 1/2" direction. This piece will be the aft fuselage cover.



Test the fit of the aft fuselage cover, and trim to fit until satisfied. Once you are happy with the fit, glue the cover on with CA. I used masking tape to hold the cover in place until the glue cured.

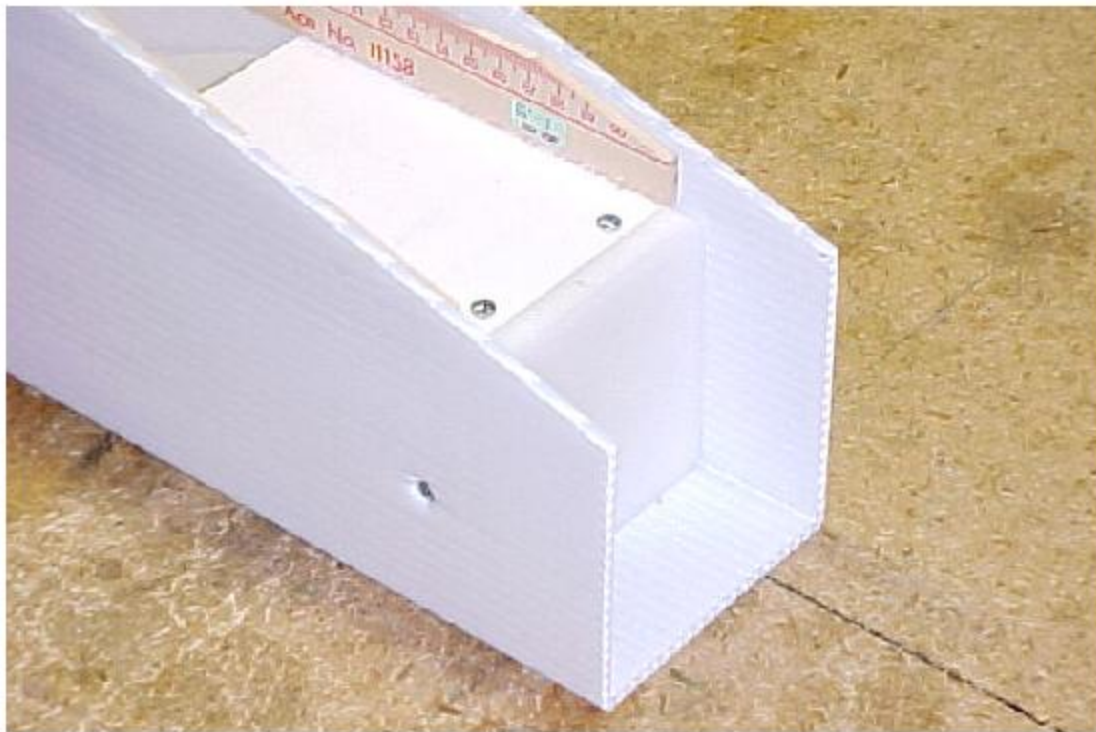

Now we'll mount the firewall to the fuselage. Insert the firewall into the PVC former, and check the fit - once you are satisfied with the fit - drill six $7/64$ " holes into the PVC former, and the HDPE firewall, and fasten it with six #6 \times $3/4$ " screws. The exact location is not critical - but it helps to know where your engine mount bolts and/or nuts will be so you can avoid a conflict with them later. Make sure that you drill the holes for the firewall mounting screws into the smaller firewall piece that is on the inside of the PVC former (as shown in the picture above)

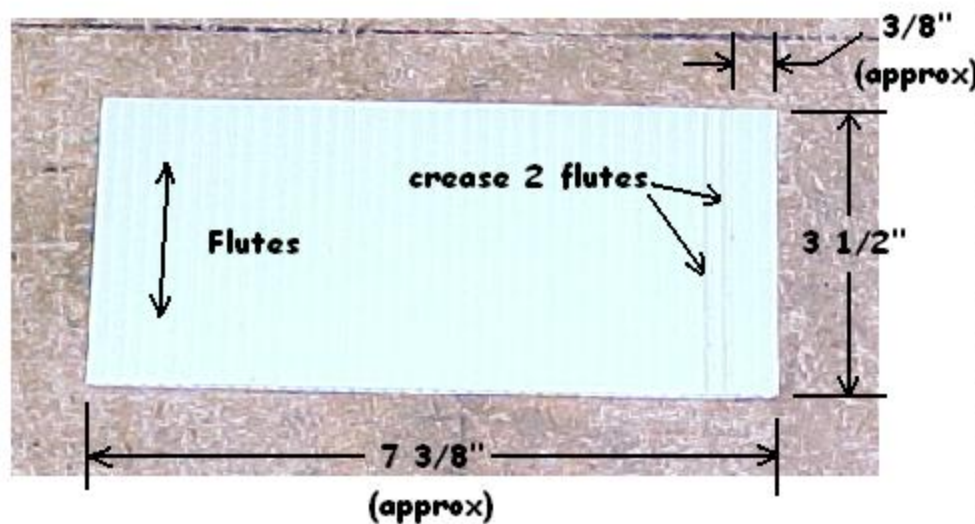

Cut out a piece of 4 mil for the forward cover following the measurements given in the picture - make sure that the flutes run in the $3\ 1/2$ " direction. Measure in $3/8$ " (approx) from one edge, and crease the flute, and the one next to it. The flutes are creased to allow the forward part of the cover to fold down (see next page). Check the fit on the fuselage and glue in place with CA when satisfied.

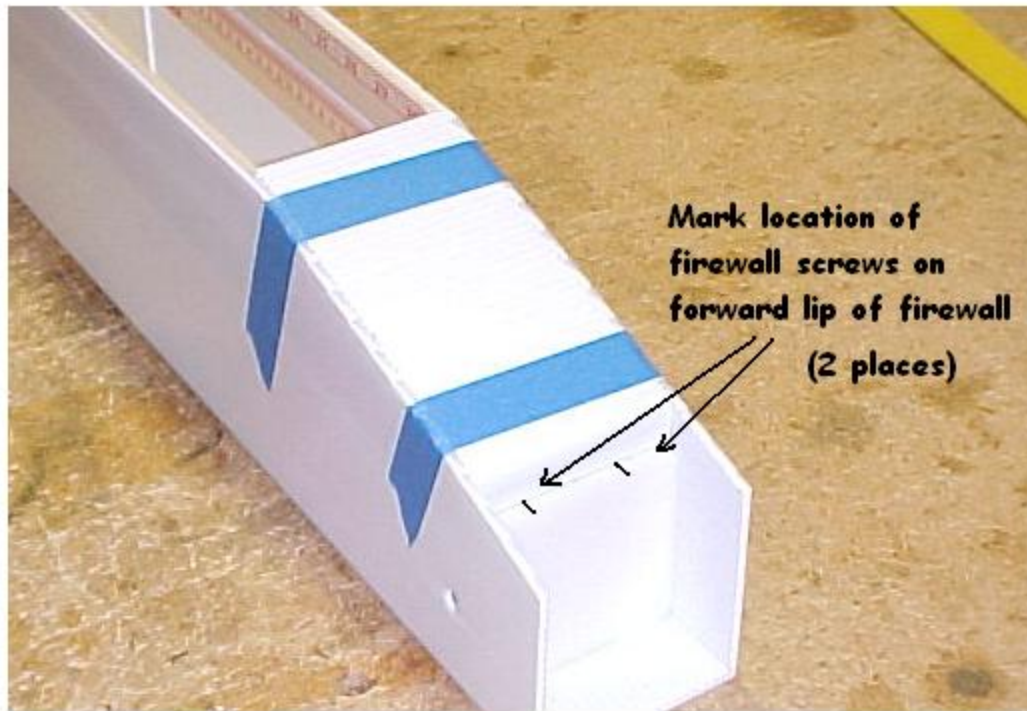

Mark the location of the upper firewall mount screws on the lip of the forward half of the firewall (these marks will be used later to cut screw access holes in the upper cover). Once you get the front cover cutout and fit the way you like it, glue it in place with CA and let it sit until the glue dries. I use masking tape to hold the cover in place while the glue is drying.

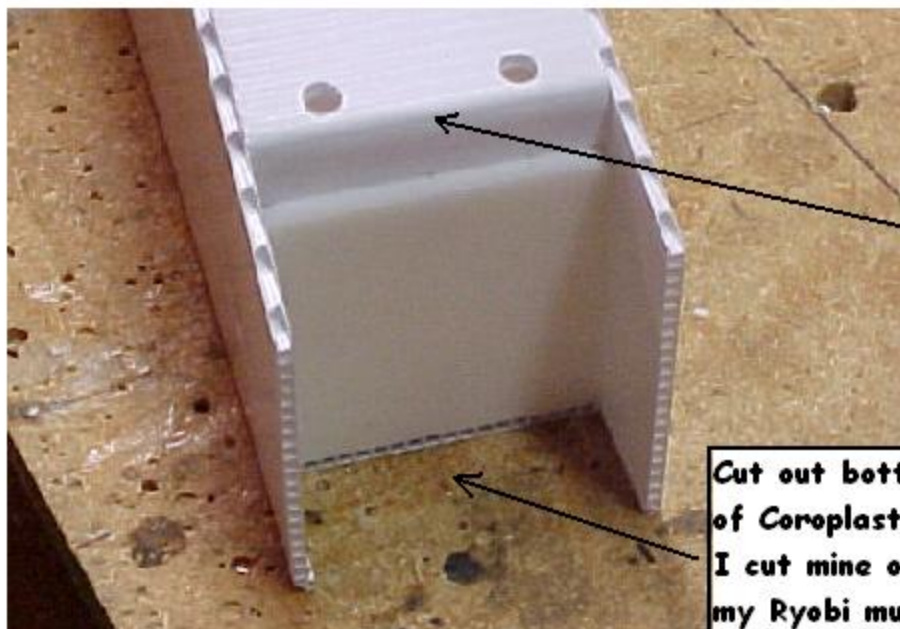

Once the cover is dry, cutout the upper firewall screw access holes (so you can get to the upper firewall screws). I used a dremel with a small grinding tip to make the holes in the cover. I also cut out the bottom piece of Coroplast that extended in front of the lower portion of the firewall to clear my Ryobi muffler. Depending on the engine you are using - you may or may not have to remove it.

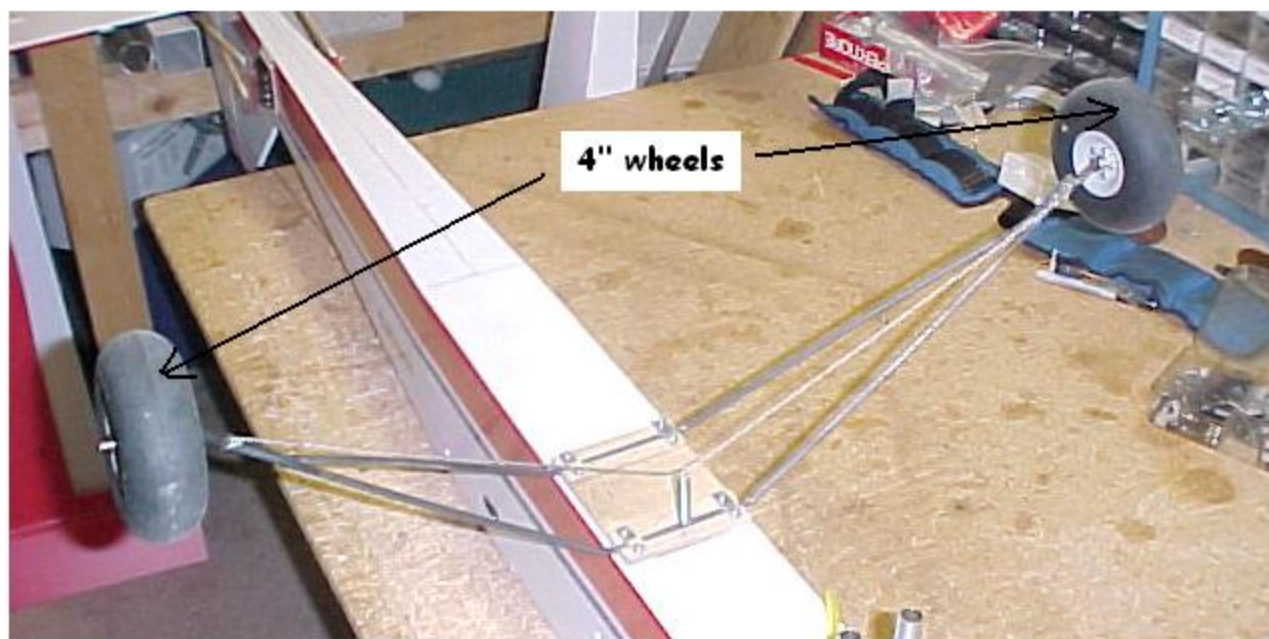

The landing gear I chose to use is simply made from 3/16" music wire that I cold bent in a vice with a hammer. I had to add a safety wire cross brace and spring to mine to minimize the flex of the landing gear - so I would recommend using 1/4" music wire for yours. The landing gear measures 25" across, and 11" in height. I spaced the two wires about 3 1/2" apart at the base (so they fit into the gear blocks you will be making on the next page). I TIG welded mine together (where the two wires meet at the outside edges - by the wheels), but if you are good at silver soldering, you could probably attach them that way. I won't go into too much detail about the landing gear - because you might have a better way of doing yours, or you might be able to get landing gear at the LHS, or, you might have a spare set of gear that would work. Just make sure that they are tall enough to give you good prop clearance, and that they can support the weight of the plane (mine weighs 13 1/2 pounds!). You can use the dimensions in the text above to give you a general idea of the size I made mine.

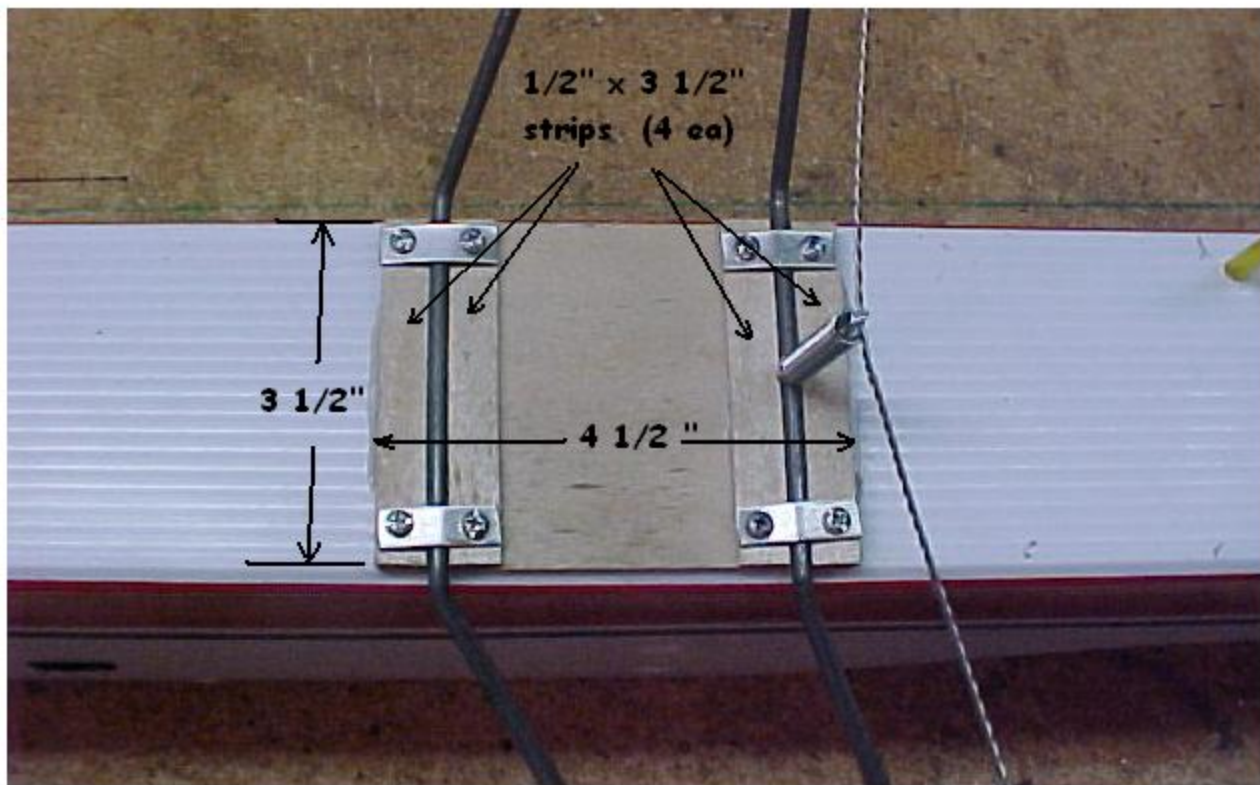

I decided to use aircraft grade $1/8$ " plywood for the landing gear plate and blocks - I know, I know - it's wood - but it was the best material I could come up with to make the gear plate/block assemblies - and so far - it has held up great! Cut out a piece of $1/8$ " aircraft grade plywood measuring $3\ 1/2$ " \times $4\ 1/2$ " - and glue it on the bottom of the fuselage (with Goop) so the leading edge of the landing gear plate is six inches back from the front of the firewall (let dry overnight). Then cut out four $1/2$ " \times $3\ 1/2$ " pieces of $1/8$ " plywood for the wire gear "lock" blocks. Glue one block even with the front edge of the gear plate, and one flush with the aft edge of the gear plate. Glue the other two blocks in place so they are spaced the thickness of the landing gear wire. I used 5 minute epoxy to glue the blocks to the plate. Make four each $1/16$ " (approx) thick aluminum strips (approx $3/8$ " \times $1\ 1/8$ ") cut to fit over the blocks. Put the gear in place and attach with the four aluminum strips, and eight #6 \times $3/4$ " sheetmetal screws (use a $7/64$ " drill bit). The screws need to go all the way into the PVC former inside the fuselage for extra strength.

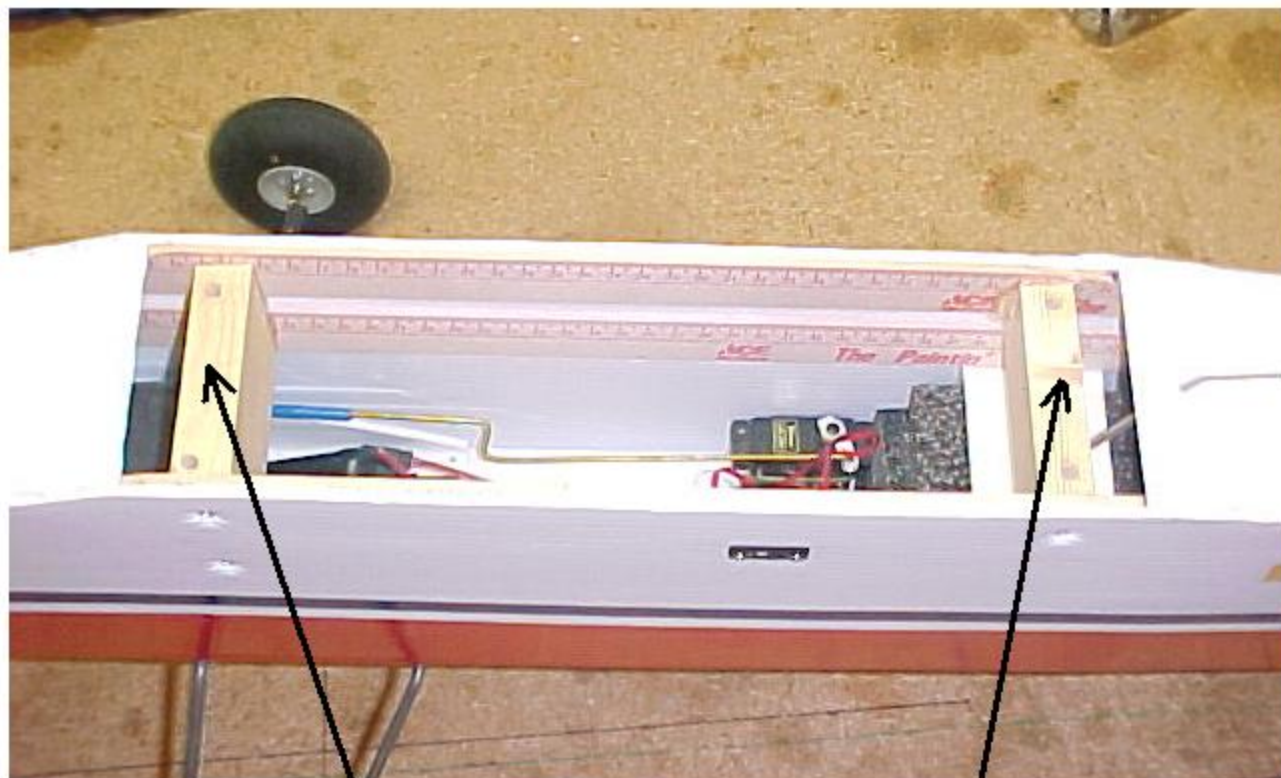

**Forward wing
holddown block**

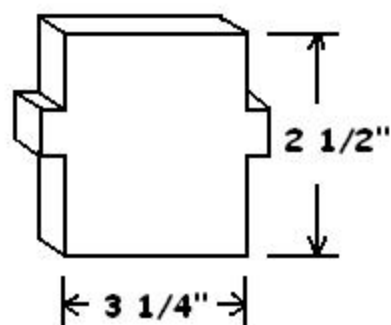

**Aft wing
holddown block**

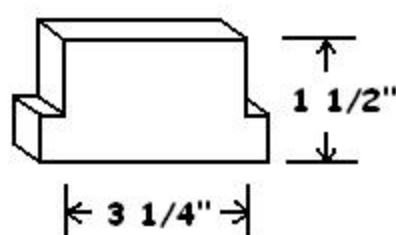

(wing holddown block drawings
not to scale)

Make two wing holddown blocks from some 3/4" pine, or a similar suitable substitute. Cut the blocks to the dimensions above. The "lugs" on the sides of the blocks measure approx 1/8" thick x 3/8" high. Make your block lugs the correct size to fit between the two yardstick doublers on the top of the fuselage in the radio opening. Also - measure the opening in your plane and adapt/change any dimensions as necessary to make the blocks fit nice and snug in place. Once you get the blocks to fit the way you want, glue them in with a 20 or 30 minute epoxy. Space the two blocks 10 1/4" apart (inside edge - to inside edge) - centered in the fuselage opening. The actual holes for the wing holddown bolts will be drilled later once the wing assembly is complete.

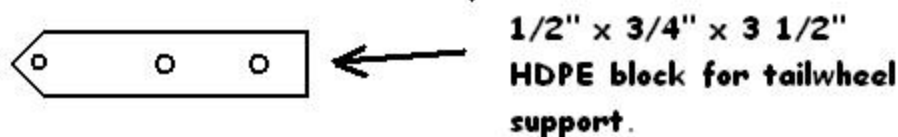
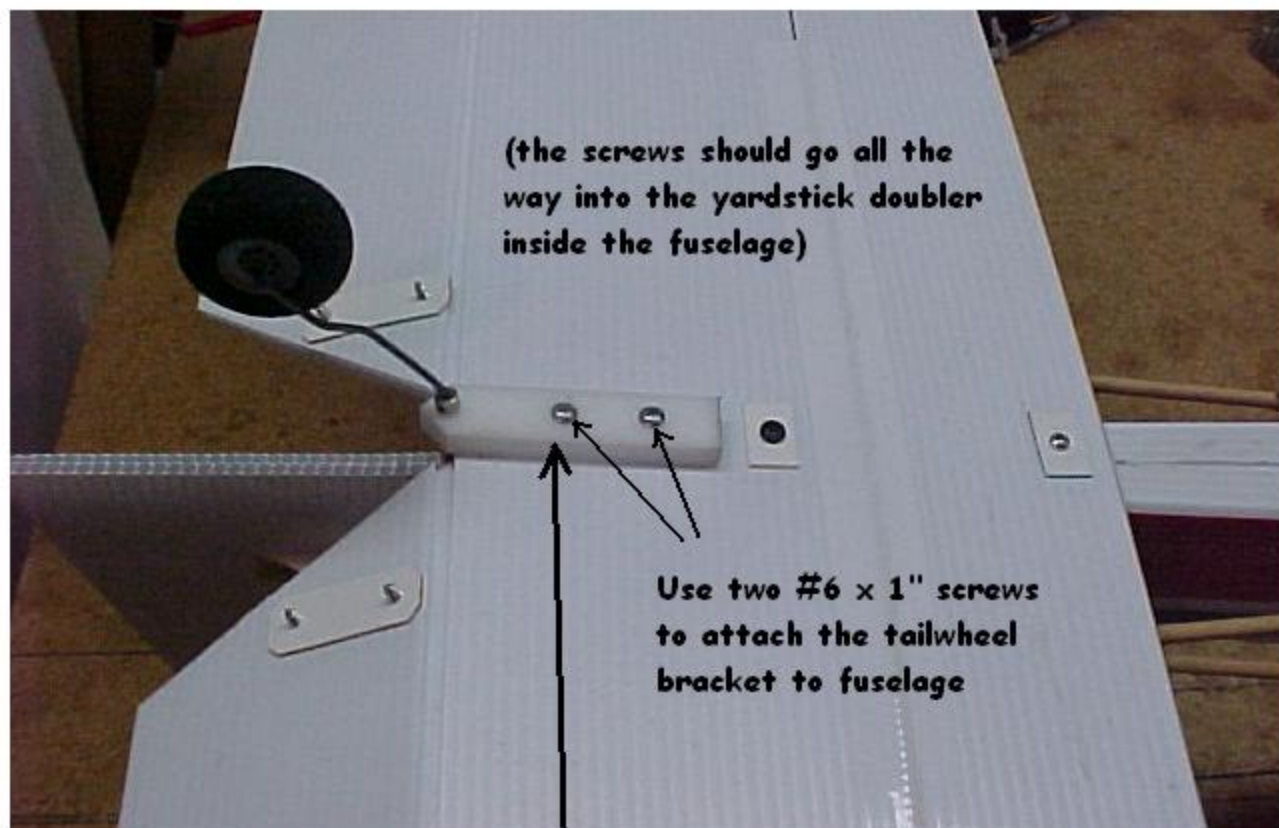

Make a tailwheel support bracket from some 1/2" HDPE - cut to size using the above measurements. I made a tailwheel wire assembly from some .080 music wire - and you should figure on making your own as well - unless you want to try and adapt an LHS tailwheel wire assembly yourself (you're on your own there). I used a 2 inch wheel for my tailwheel - and I made the tailwheel wire something like what is shown below. Definately focus on function over form!!! :-)

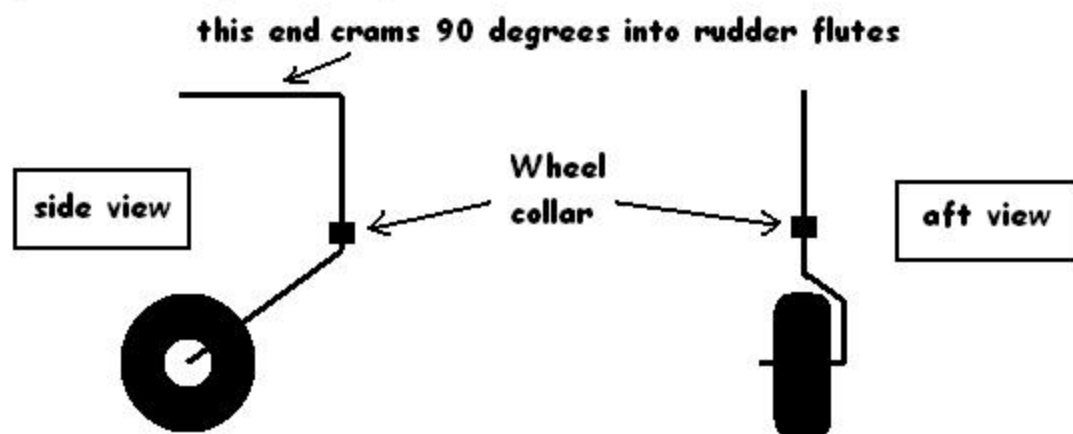

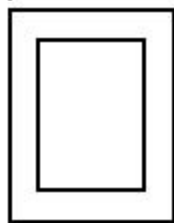

I cut out a rectangle shape from a piece of 1/8" plywood to mount the servos in. I made the piece 3/4" longer than the length of a single servo, and 3/4" wider than the width of two servos. That gives you a piece that looks like a picture frame - with a 3/8" border all the way around. Mark the location where you want to put it, and cut out the Coroplast where the servos will go. Make sure that the internal formers and the vertical stab won't interfere when determining where you want to place your servos. Once you have determined a good location, cut out the Coroplast at the I.D. of the servo mount frame only - then glue the plywood servo mount on with CA. Once the glue is dry - mount the servos using standard servo screws. I made my own pushrods from 1/4" dowels and 4-40 hardware. The horns are made from PVC, and cover at least half of the chord of the control surface - but you can use any type of control horn you are comfortable with as long as it can take the load, and won't cause flutter. I also added flying wires to the vertical and horizontal stabilizers to minimize the risk of tail flutter. I used .032 safety wire, and some small LHS landing gear brackets to attach the flying wires to the stabs. I glued some small scraps of PVC to the stabs to give the brackets a firm attach point.



I forgot to mention in the previous page that I set up my Ultra SPADstick with dual elevator servos - that way you can use standard servos - and they will be strong enough to do the job safely.....so this picture shows the righthand side, and the other elevator servo. Again - I used 1/4" dowels and 4-40 hardware to make my own pushrods. One thing I need to mention - I used a "Y" harness to connect the elevator servos to the receiver - so that means I had to hook up the L/H side elevator servo with the servo control arm facing down, and the R/H side elevator servo control arm facing up - that gives you elevator motion in the same direction! I made another 1/8" plywood servo mount for the single servo the same way I made it for the L/H side - only big enough to fit one servo. Place the R/H elevator servo directly across from the L/H elevator servo so the distance from the servo control arms to the elevator horns will be identical. The tailwheel wire (which has been inserted in the flutes - perpendicular to the hinge line) is sandwiched in between the rudder horn and the rudder horn backplate.

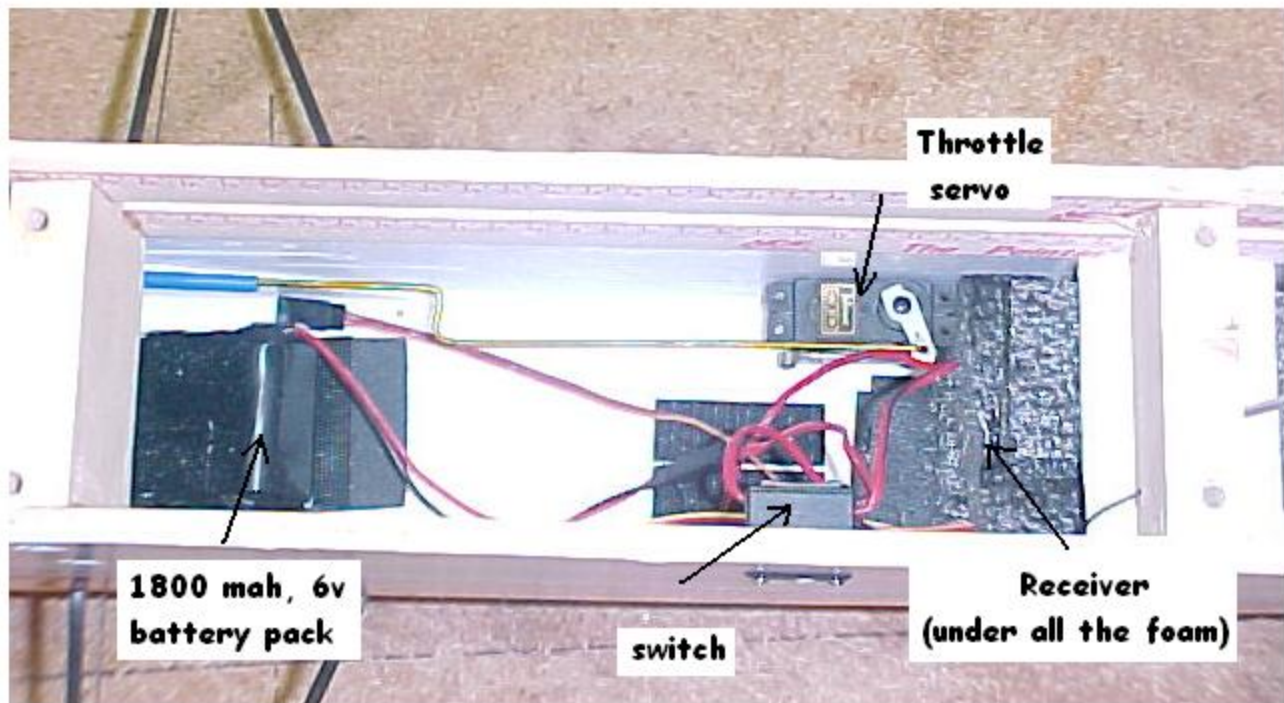

If you use a Ryobi 31cc engine for your Ultra SPADStick - this is the basically where your radio gear will end up being placed. The two elevator servos (with the "Y" harness), and the rudder servo leads will each reach the receiver with a 12" servo wire extension lead. I used velcro to hold my receiver and battery in place. Just make sure that everything is held in place very securely since the gasser engines vibrate more than most smaller R/C engines.

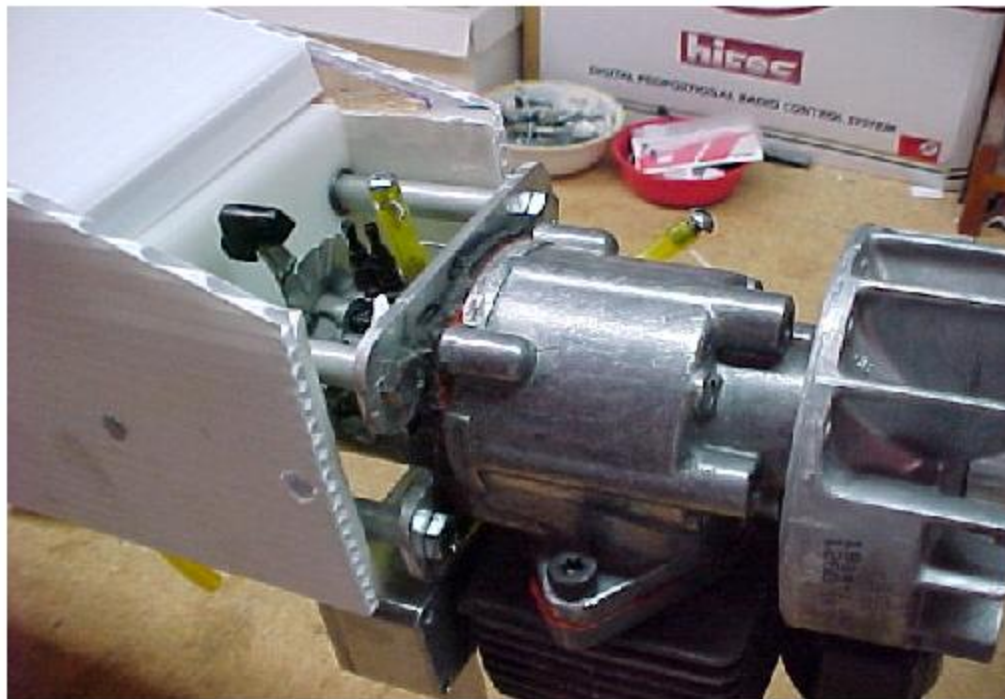

This picture gives you an idea of how I mounted my Ryobi 31cc engine. I won't go into specifics about mounting your engine - because of the wide variety of engines available - and the different preferences people have. This picture is simply for a reference.

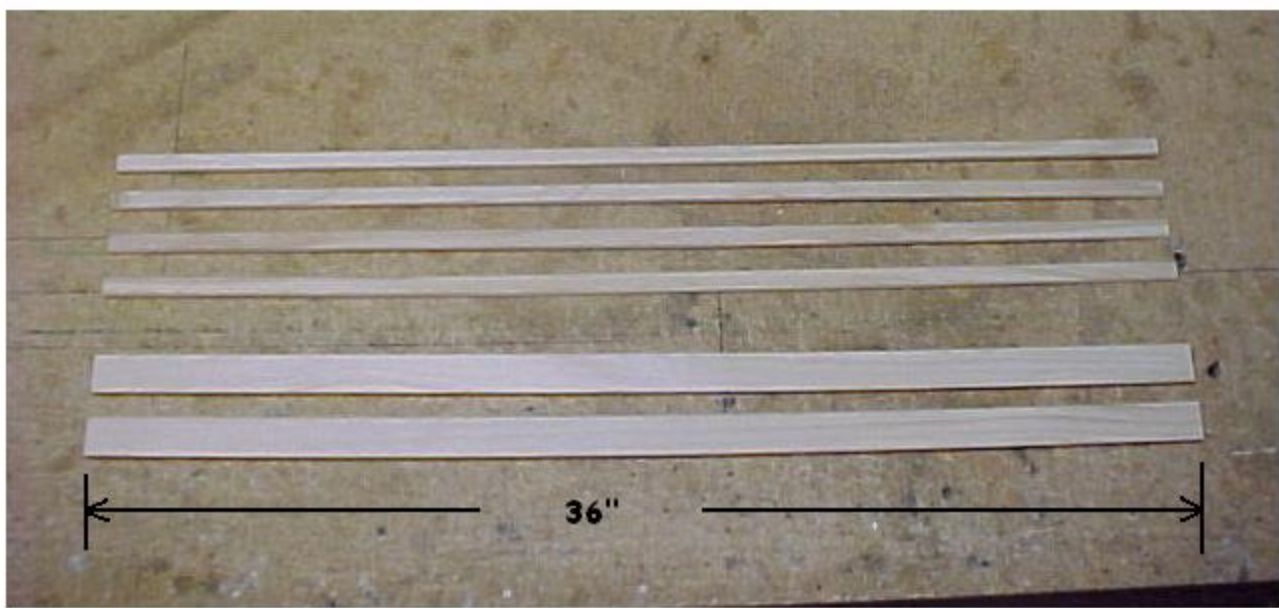

Next we'll make the wing. I used some 1 1/4" wide x 1/4" thick pine lattice wood strips for the main spar, and some 3/4" x 1/8" pine trim molding to make the spar cap strips. Cut the spar pieces to length. Cut four of the 3/4" pieces, and two of the 1 1/4" pieces to make a complete spar. I glued the two 3/4" strips onto the 1 1/4" lattice piece (one on top, and one on the bottom - but don't do it now - we'll glue them later). The final spar looks like an "I" beam when it's done. Next we'll make the spar doublers.

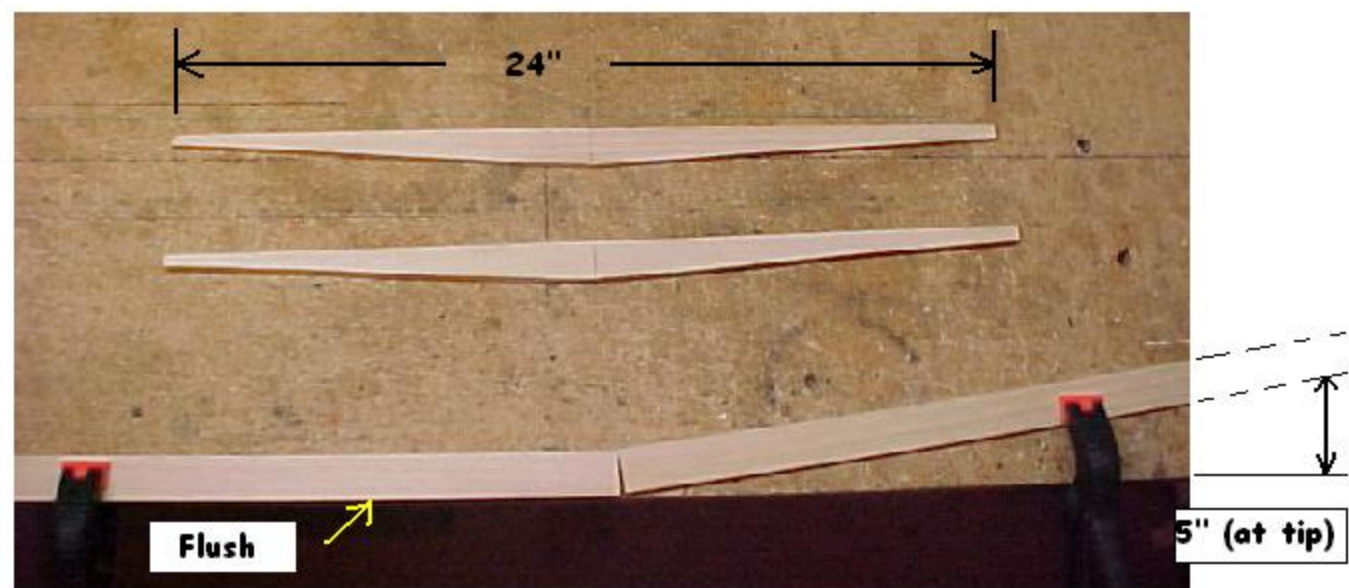

Make two spar doublers (24" long) from the same material that you cut the spars from. Lay the two spars down on the table so that one side is flush with the edge of the table (like the above picture), and one end is 5" up from the edge (for the dihedral). Lay the two spar doublers on top of the layed out spars and mark and cut the angles of the bottom of the spars so the doublers will fit flush with the bottom of the spars. Glue the doublers to the spar with 20 or 30 minute epoxy, and clamp them for a nice strong joint.

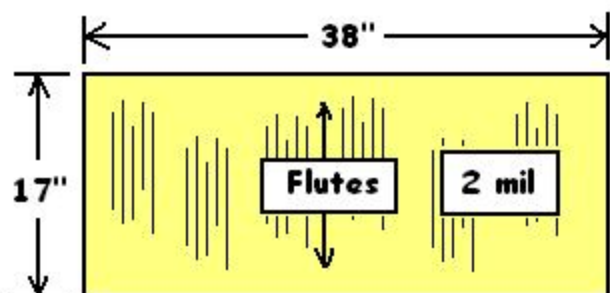

Upper wing panel (make 2)

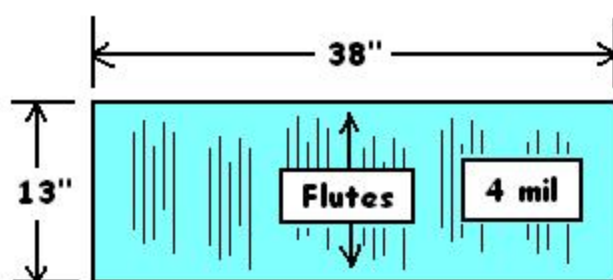

Lower wing panel (make 2)

Make 2 each upper and lower wing panels according to the dimensions shown above. Make sure to notice which panel is made from 2 mil Coroplast - and which panel is made from 4 mil Coroplast.

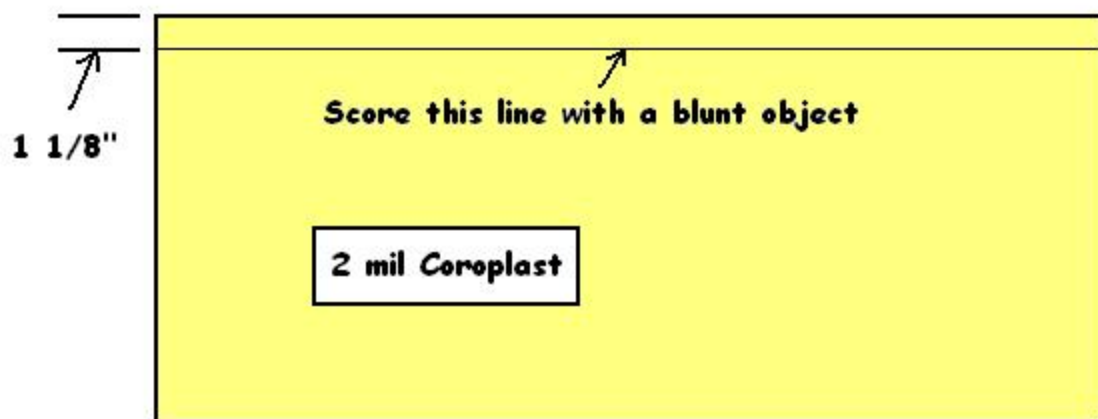

Take both 2 mil upper panels and measure & mark as shown above. Using a blunt tool - score on the line that you drew, then bend the panel on the line to ensure it bends easily.

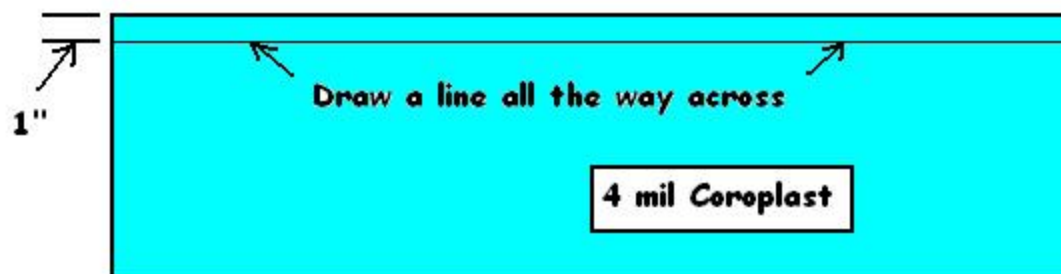

Next - take both lower 4 mil wing panels and measure & mark as shown above - this time - instead of scoring the line - just mark it with a pen or marker. This line will be where you will position the 2 mil upper wing panel, and the 4 mil lower wing panel when you glue them together.

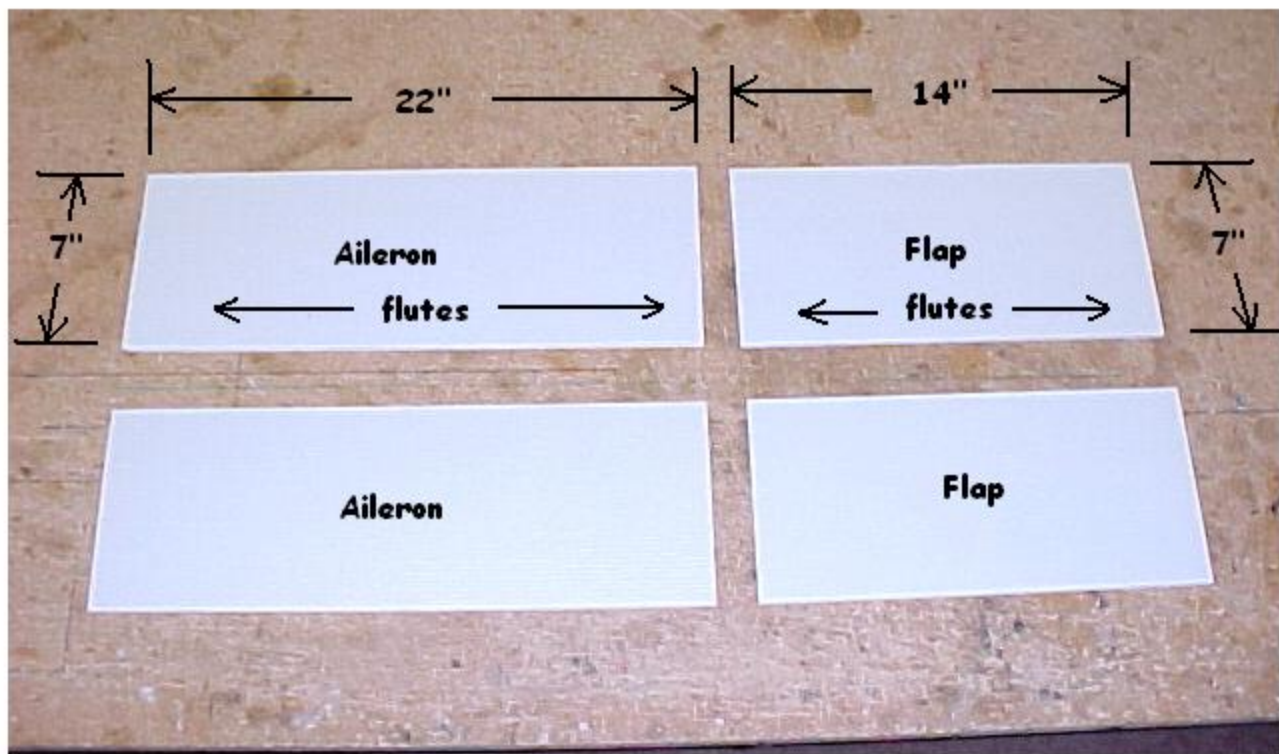

Cut out four pieces of 4 mil Coroplast as shown above - these pieces will be the ailerons and the flaps. Make sure that the flutes are running in the long dimension direction. If you don't want to make flaps - just make two pieces that measure 36" long. These four pieces will be doubled over and glued back on themselves to make a nice, stiff control surface to help minimize flutter.

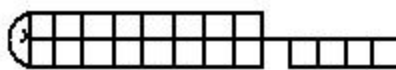

This is what the control surfaces should look like when done

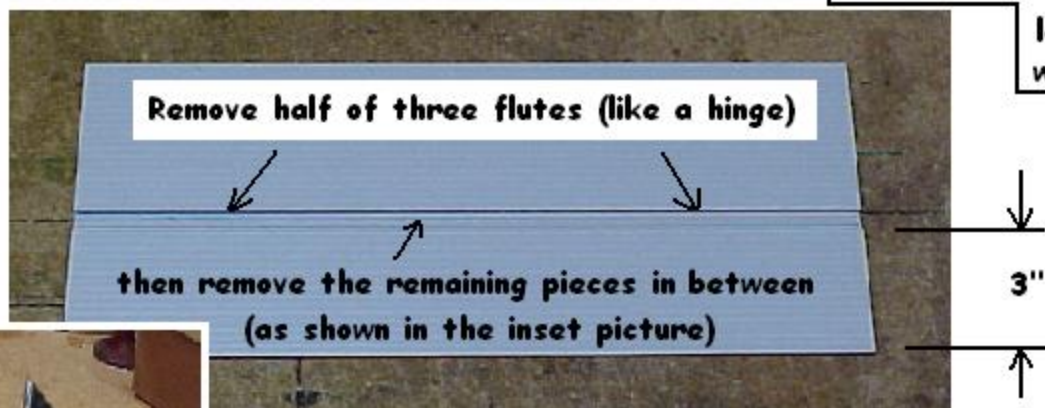

The ailerons and the flaps are made by cutting out three flutes (like making a hinge) so they can fold back easily to make a doubled up control surface to minimize the risk of flutter. The part that you are removing the flutes from will end up being the trailing edge of the ailerons and the flaps. Once the piece has been glued - cut out half the flute to form the hinge - just forward of the folded over 3" piece edge.

1 1/2"
(2 places)

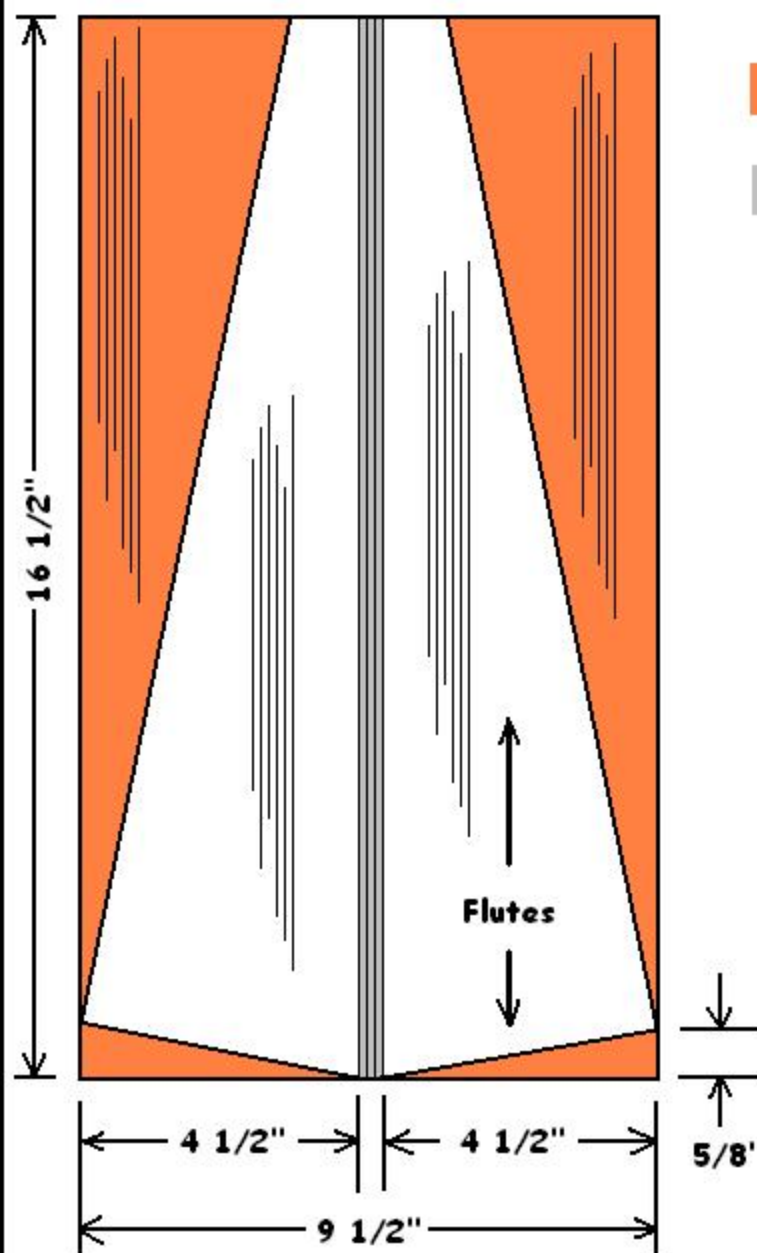

remove 3 flutes and the remaining pieces in between (like with the ailerons and flaps)

Orange = Scrap
Grey = removed flutes

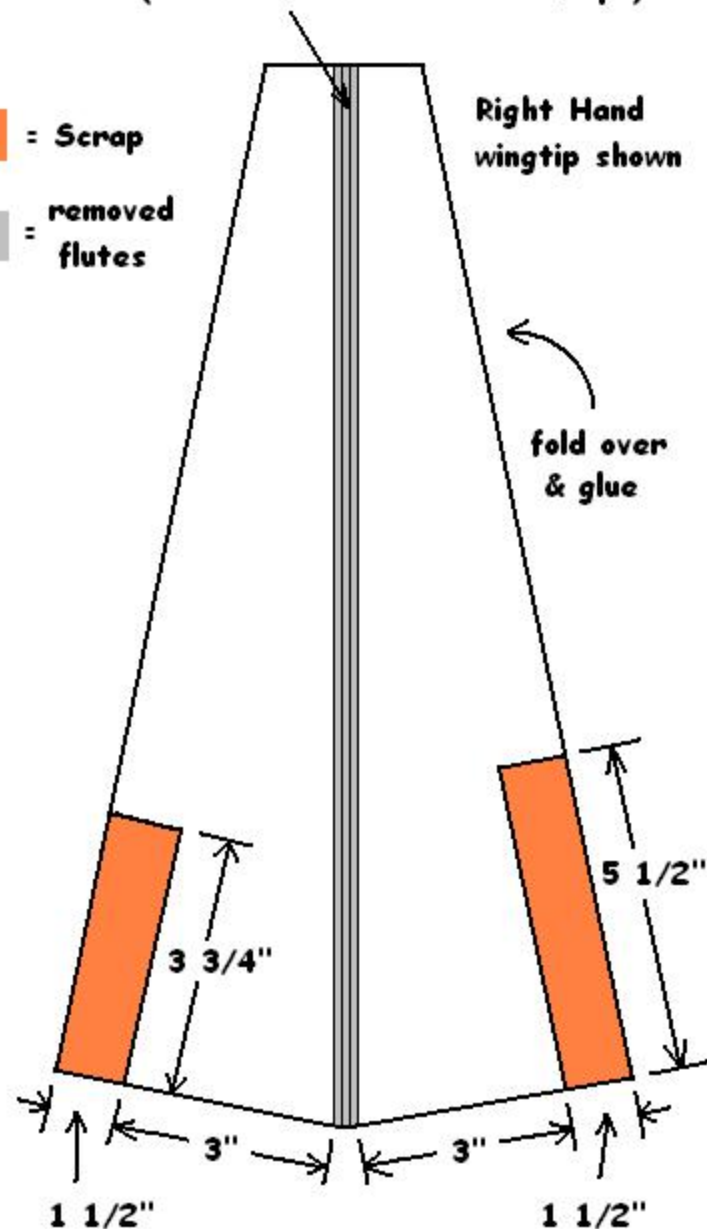

Making the wingtips - while not a difficult task itself - can be somewhat tricky to explain how to do.... but I'll try the best I can - and hopefully the illustrations will help. Cut out two pieces of 4 mil Coroplast measuring 9 1/2" x 16 1/2" - with the flutes running in the 16 1/2" direction (one each for the L/H & R/H wingtips). Measure and cut out all pieces colored brown. Cut out the 3 middle flutes, and the 2 pieces in between (just like you did for the ailerons and flaps) so the wingtip can fold over and be doubled up. Test fold the wingtip after making all the necessary cuts - and once you are satisfied with the fit - fold the piece over on itself and glue it with CA. Make sure the edges line up OK while gluing. After finishing the Right Hand tip (as shown above) make a Left Hand tip by simply switching the small cutout measurements.

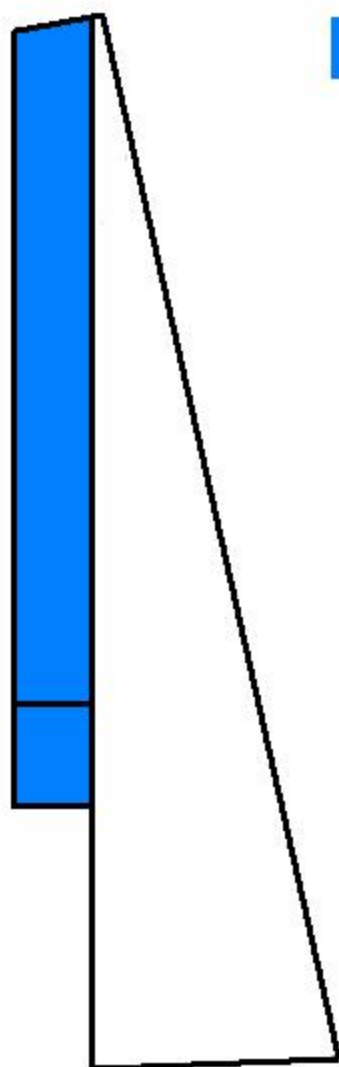

 = Gluing surface

Completed Right Hand wingtip - ready to be glued to lower wing panel. Now make a Left Hand tip by switching all the measurements

After you finish cutting out both the right hand, and the left hand wingtips, fold each one over on itself and glue it with CA. This process makes the wingtip 8 mil thick - with a nice rounded edge. The inner part (the part shown in blue) is where the glue will be applied to attach the wingtip to the bottom wing panel, and part of the upper wing panel (shown later). You should end up with a wingtip that looks like the drawing above (the right hand wingtip is shown above - and the left hand wingtip will be a mirror image of the right hand wingtip).

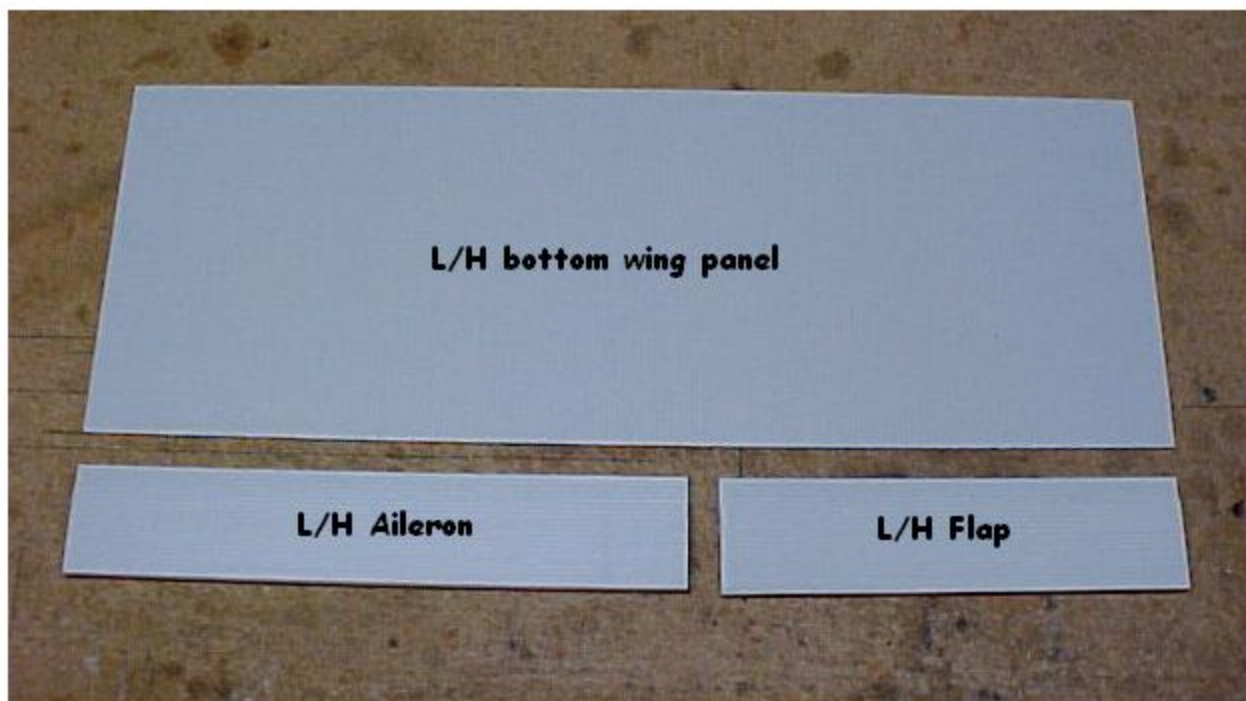

Next - test fit the aileron and the flap to the bottom wing panel. The picture above shows the left hand bottom wing panel, and the L/H aileron & flap. Position the aileron flush with the outboard edge, and position the flap next to the aileron with about a 1/8" gap between them. Due to the length of the aileron and the flaps - you will end up with a 2" gap at the inboard part of the wing panel (see picture below) - this gap is good - it is there to clear the fuselage when the flaps are deployed). Position the aileron and the flap on the bottom wing panel aft far enough so that the hinge gap is completely exposed - but even with the edge (so the aileron and the flap can move their full travel). After checking the fit of the aileron and the flap - glue them in place with CA. Make the right hand panel just like the left hand panel - only make it a mirror image!

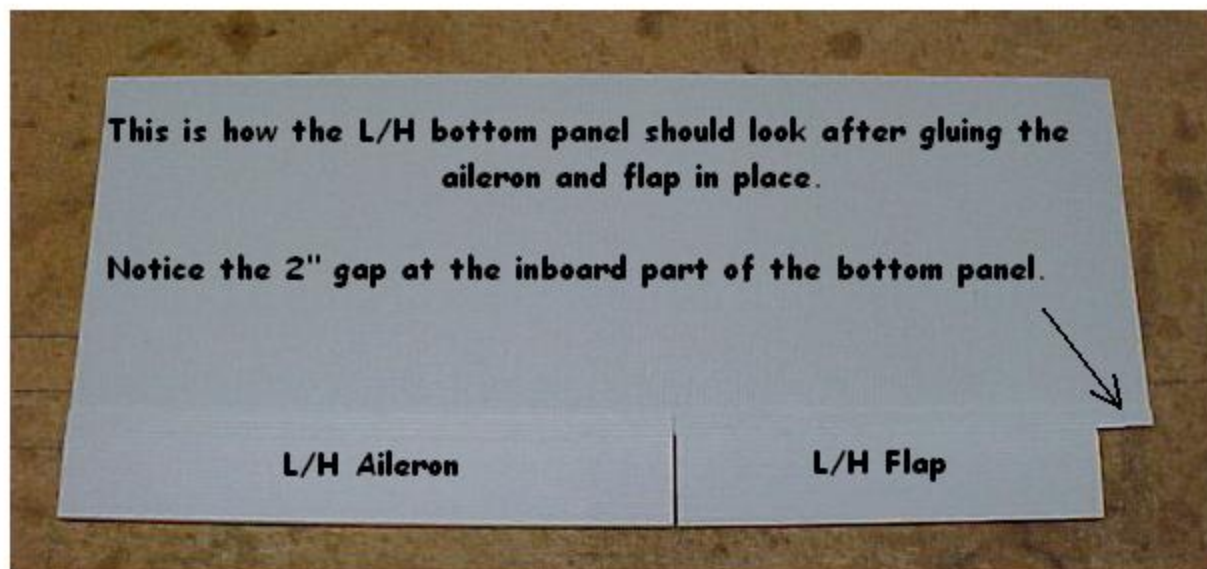



Now take the upper wing panels you made earlier and glue them to the lower wing panels with CA. Follow the marks you made to ensure that you get them glued on square and even. The right hand wing panel is shown above. Make sure that you make a right and a left

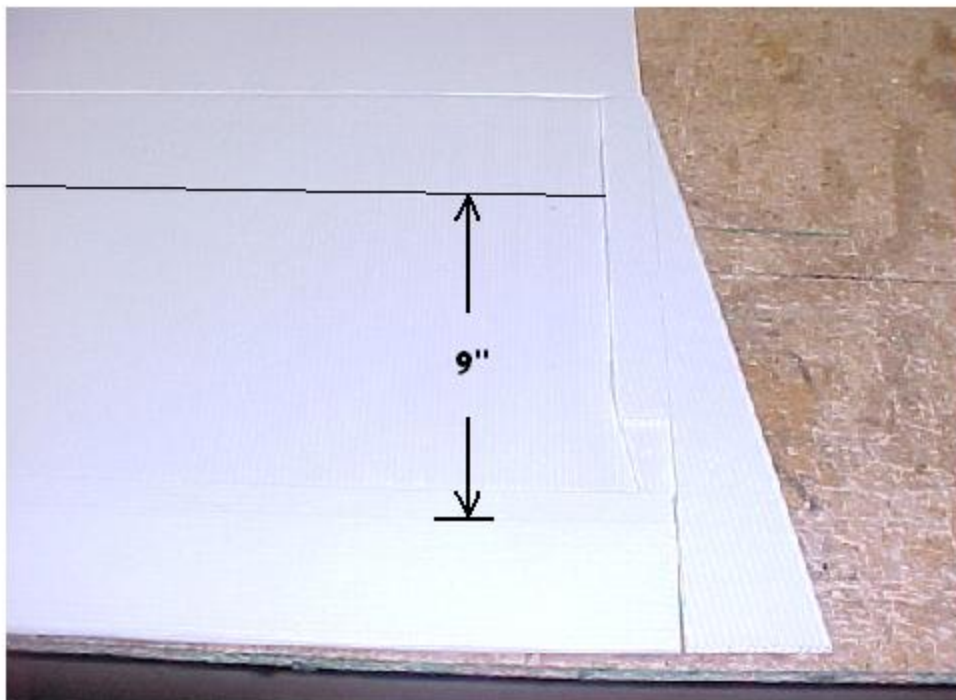

Next - glue the wing tips to the outer edge so that the trailing edge is flush with the outboard edge (so it doesn't interfere with the ailerons).

Draw a line on the bottom wing panel measured up 9 inches from the aileron and flap hinge line - this is for the spar location. Make sure that you mark both left and right panels. Next we'll glue down the spar.

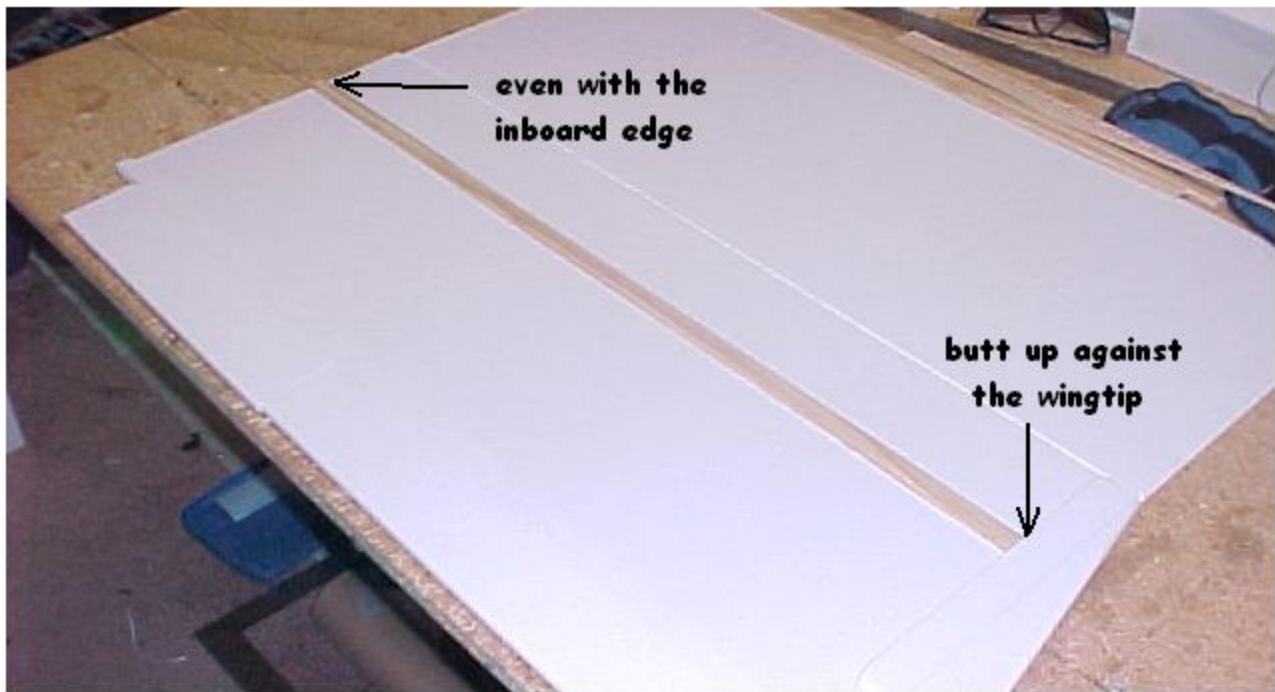

Take one of the four $3/4" \times 1/8"$ pine spar cap strips and glue it to the bottom wing panel - centered over the spar line you just drew. The spar cap strip should be butted up against the wingtip edge, and flush with the inboard edge. I used CA to glue the spar cap strip down. Shown above is the right hand wing panel - be sure and glue the spar cap strip on the left wing panel just like you did for the right one.



Glue the previously completed spar assembly on top of the spar cap strip. Make sure that you center the spar (forward and aft) on top of the $3/4" \times 1/8"$ cap strip, and make sure that it is positioned correctly left and right. I glued my spar down with 30 minute epoxy. Use some weights to hold the spar down while the glue cures.



Now glue the other spar cap strip on top of the spar. Glue the top spar cap strip on with epoxy. From the side, the spar now looks like an "I" beam - as illustrated below. We'll finish the right hand panel before we start attaching the spar to the left hand panel.

Side view of spar and spar cap strips

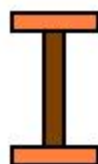

 = spar cap strips
 = spar



Cut two 1" x 36" strips of 2 mil coroplast (one for each panel) (flute direction isn't important) These strips will glue to the lower wing panel just forward of the aileron and flap hinge line. This strip allows the upper 2 mil wing panel to match up with the thickness of the 4 mil aileron and flap thickness. Glue the strip on with CA.

You also need to add a small 1" strip of 2 mil in the gap by the wing tip



Now temporarily fold over the 2 mil upper panel and mark it even with the forward edge of the hinge line (also - it will be even with the back edge of the 1" x 36" strip of 2 mil you just glued on). Unfold the panel and cut off the excess at the marks you made. Once the upper panel fits that way you like it - glue the upper panel to the lower panel. I used CA to glue the upper panel to the lower panel. Now that you have completed the right hand panel - make the left hand panel the exact same way. You will notice that when you try to fold the upper left hand panel over the spar (to mark it for the final cut) that it interferes with the right hand upper panel that you previously glued. You will need to cut out a slight radius from the upper left hand panel for clearance. Just cut away small amounts until it clears sufficiently. If you make too big of a cut - all is not lost - because the center wrap will hide the error.



This picture gives you an idea of what the left hand assembly process looks like. I recommend that you put something under the right hand wingtip to support it so your wing doesn't keep trying to play teeter-totter.

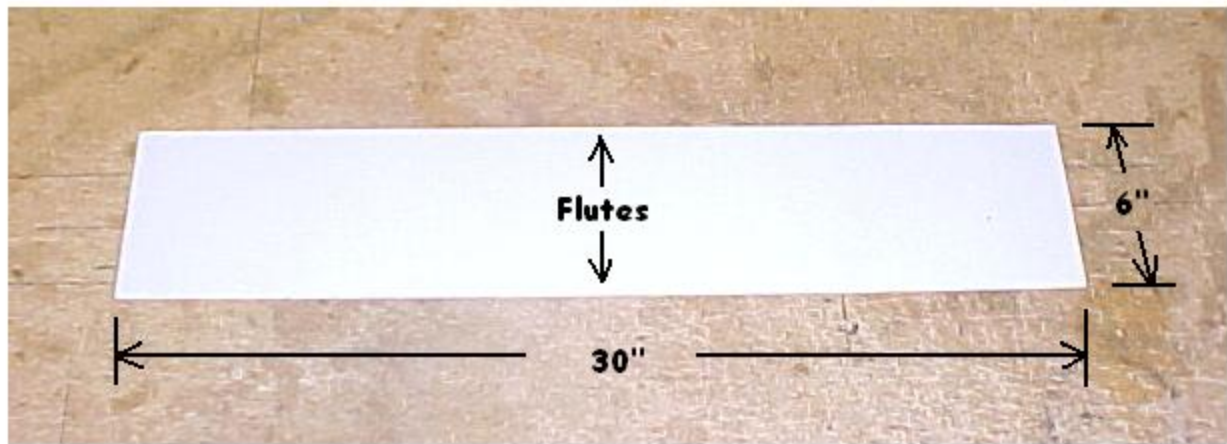

Cut out a piece of 2 mil measuring 6" x 30", with the flutes running in the 6" direction. This will be the center wrap.

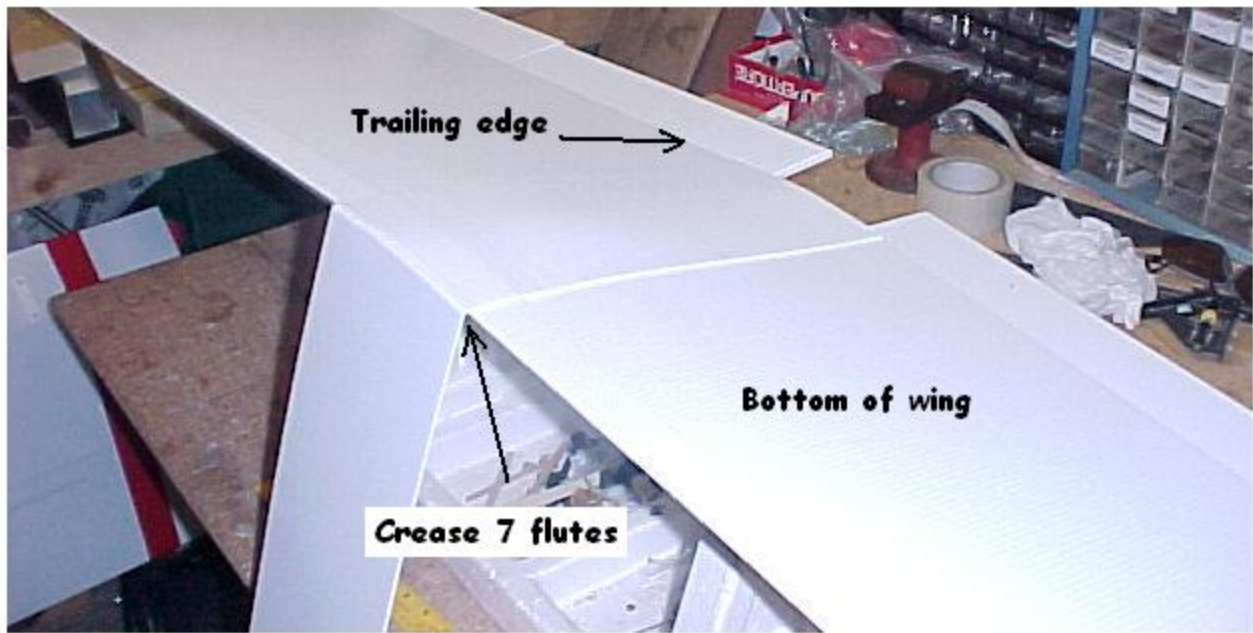

Lay the wing upside down, then lay the center wrap on the wing so that the center wrap is even with the lower panel trailing edge. Mark where the front of the center wrap is even with the leading edge of the wing. Now flip the center wrap over and lay it on the table. Using the mark you just made, crease the center wrap all the way across (the 6" direction).....crease the next 6 flutes also. This allows the center wrap piece to form nicely around the leading edge. Once you are satisfied with the fit - flip the center wrap piece back over and glue it to the wing - make sure that the center wrap is centered on the wing. Do not put any glue on what is the upper portion of the center wrap yet. Your center wrap should like the the picture above once you get it glued down.

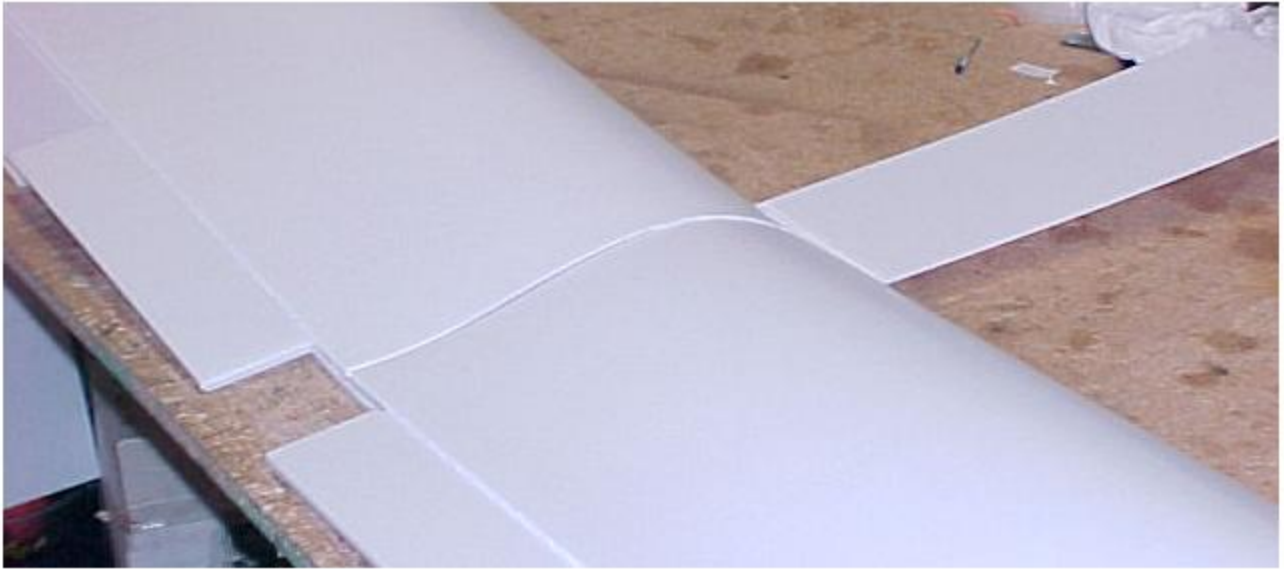

Test fit the upper portion of the wing center wrap. Make sure that you pull it smartly up and aft to check the fit. Once you are satisfied with the fit - glue the upper portion of the wing center wrap in place. You should end up with approximately 2 inches hanging over the back end of the trailing edge - just trim it off even with the trailing edge once the glue cures.



This is what the finished center wrap should look like once you are finished. Next we'll finish the wing mounts.

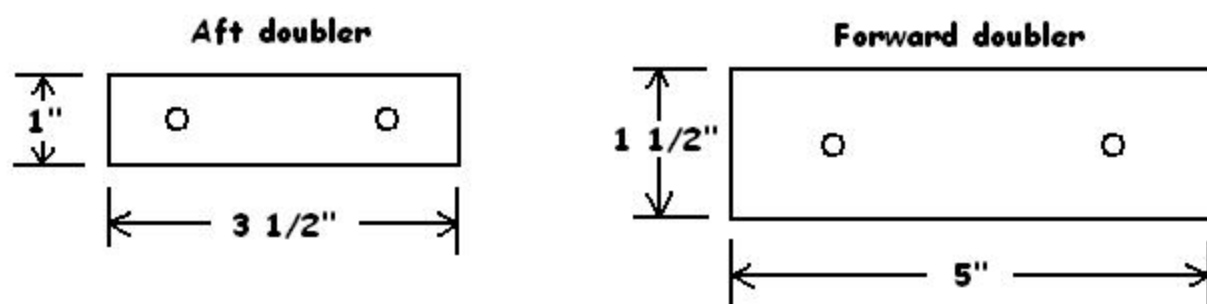

Cut out two PVC wing holddown doublers according to the above dimensions. Drill two 1/4" holes in each doubler spaced 2 1/2" apart, centered both up & down, and side to side.

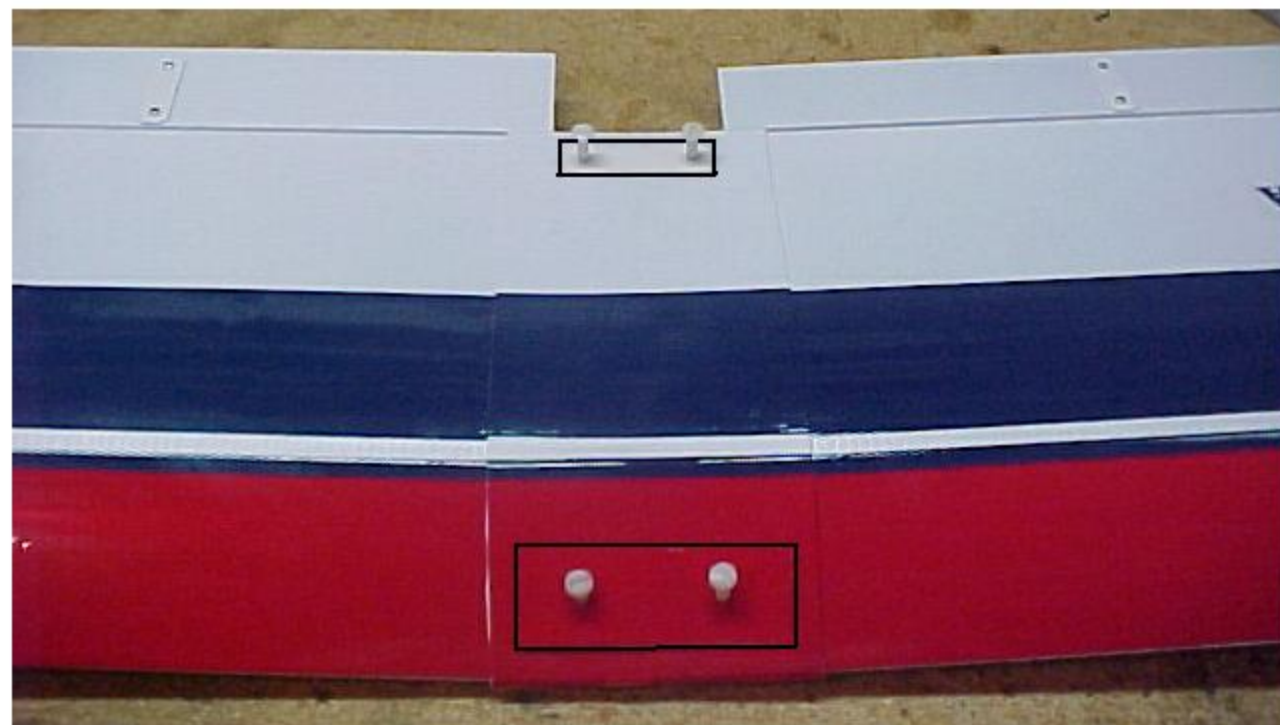

Glue the doublers on the wing (centered left & right, and forward & aft onto the 2 mil wing center wrap), so that the holes are exactly 11" apart. The 11" spacing of the 1/4" holes in the PVC doublers mirrors the centered distance that the wing holddown blocks measure that you mounted during the fuselage construction. Drill a hole in the wing through the 1/4" holes in the PVC doublers - ensure that you drill the hole through the wing straight up and down. You might need to wallow the holes out slightly to allow the 1/4" nylon bolts to fit through the holes. Temporarily set the wing on the fuselage and ensure that the wing is square and level. Take a pen or pencil and mark through the doubler holes to the holddown blocks mounted in the fuselage. Remove the wing and drill out the holes in the holddown blocks with a 7/32" drill bit. Now run a 1/4"-20 tap down the holes to cut threads for the 1/4" nylon mount bolts. Take some thin CA and run it down the holes to give the wood threads some extra strength. After the CA cures - run the 1/4" -20 tap back into the hole to clean it out. Put the wing back on and check the fit

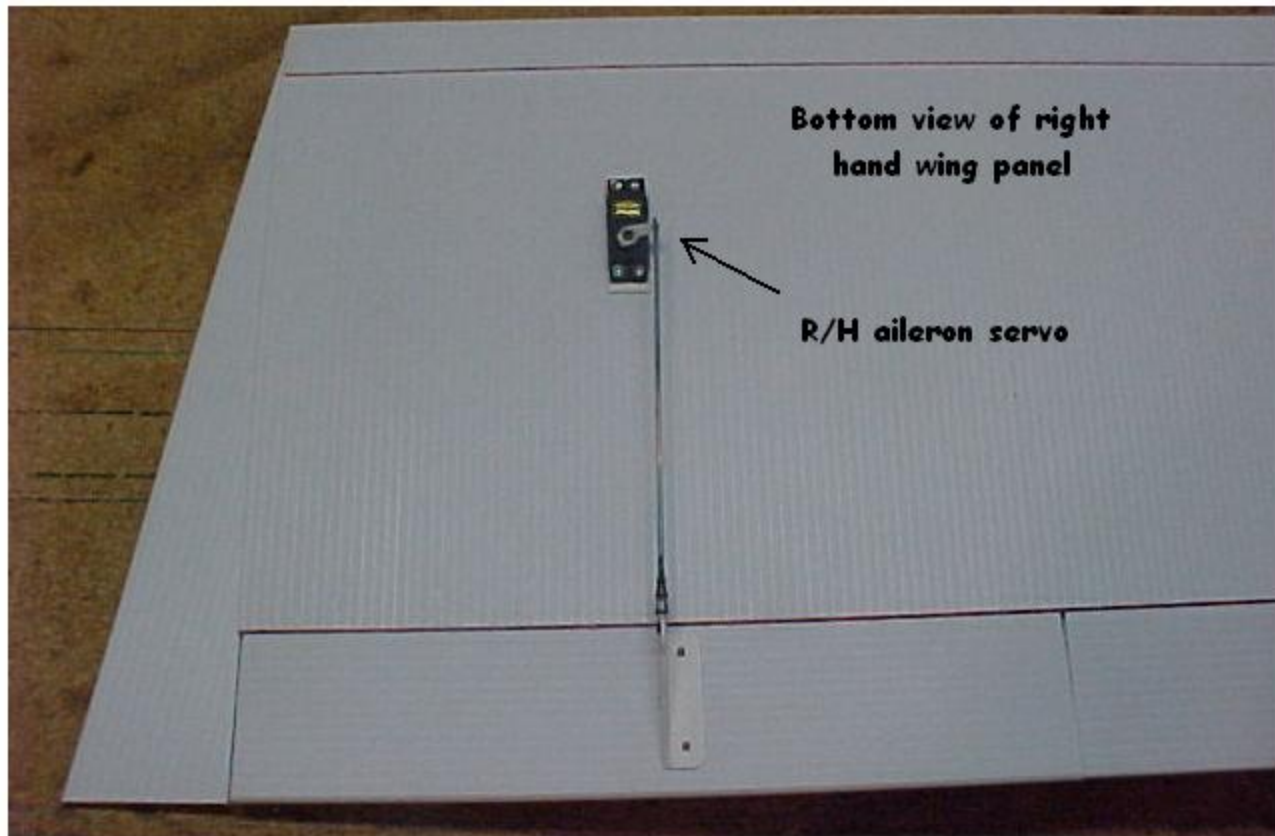

This is how I mounted my servos. I used one servo for each flap and aileron (for a total of 4 servos on the wing). The distance between the aileron servos and the center of the wing required some 24" extensions to reach the "Y" connector. The flap servos were close enough together that they reached the "Y" harness without any extensions.



Here is how my wing looked with all the servos mounted. I cut a 1 inch square hole in the bottom, center of the wing for the aileron and flap "Y" connectors to exit.



Once you have all the parts built, assemble the plane and check the CG. I set the prototypes CG at the spar - which is approximately 25% - and I felt that it was too noseheavy - so I moved it aft to around 28%. That seems to be a good starting point - and you might like yours even more tail heavy - just be sure and make your changes in small increments so the plane doesn't become too unstable. I set all the throws to max travel (except flaps - limit them to about 45 degrees) - and I dialed in about 60% exponential. The plane flies very solid, and the Ryobi 31cc offers excellent performance - but the plane does not have unlimited vertical - so if you really want spirited performance - go with a 45cc engine! I have noticed that the plane really likes to land with about 25-30 degrees of flaps down, and you can really come in at a higher than normal altitude for landing because the flaps and the prop really slow the plane down nicely. Make sure that you keep the speed up on this plane (until you are comfortable with it) - because of its size - its actual speed can be deceiving - and you might find yourself meeting the ground a little harder than you planned! I didn't hook my serves up in a way that permits my plane to crow, or have flaperons, or ailerons (yet!) - but feel free to experiment with the design to see if they work - just be sure and be ready to tell others how you did it!!! Above all - make sure and follow all AMA rules and guidelines - and most importantly - be safe! I hope you enjoy your Ultra SPADStick - and please share your pictures and stories with us!

Kraut